



zafferano
LAMPES-À-PORTER

zafferano
LAMPES-À-PORTER

E se fosse una lampada a illuminare l'inaspettato?

What if a lamp
could light up the unexpected?













Questo che vi proponiamo
è un breve viaggio nella natura
natura protagonista con la sua intatta bellezza.
Lampade che fanno da contrappunto a questi paesaggi
accoglienti e disponibili
offrono luoghi inaspettati, inconsueti
dove la luce, compagna fedele,
fa riscoprire colori e profili
che i tramonti vanno via via dileguando
inghiottiti dall'oscurità.

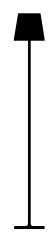

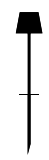

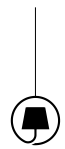
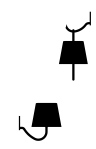
What we propose
is a short journey into nature.
With its unspoilt beauty, nature is the protagonist.
Lamps bring a contrast to these
welcoming and receptive landscapes.
They offer unexpected and unusual places,
where light, a faithful companion,
lets you rediscover colours and profiles
that sunsets gradually fade away
swallowed by darkness.



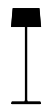

Indice delle collezioni

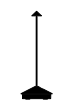

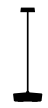

Collections overview





							
06	12	20	24	30 NEW	34	38	42
Poldina	Tavolo Table lamp	Mini tavolo Mini table lamp	Micro tavolo Micro table lamp	L desk tavolo L desk table lamp	L terra-tavolo L floor-table lamp	XXL terra-tavolo XXL floor-table lamp	Picchetto Lamp with peg





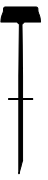

						
	46	50	54 NEW	58	60 NEW	74
Poldina	Sospensione Suspension lamp	Parete Wall lamp	Cover Cover	Poldina Reverso	Tavolo Table lamp	Ofelia Tavolo Table lamp



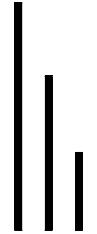

						
78	82	86	90	94	102 NEW	
Olivia	Tavolo Table lamp	Mini tavolo Mini table lamp	Pina	Tavolo Table lamp	Supporto da terra Floor stand	Vassoio Tray

					
106	108	114	120	126 NEW	130 NEW
Swap	Tavolo Table lamp	Paralumi Lampshades	Mini tavolo Mini table lamp	Paralumi Lampshades	Push-up Tavolo Table lamp

				
134	136	140 NEW	142	150
Home	Tavolo Table lamp	Supporto parete Wall lamp kit	Dama	Olimpia Tavolo Table lamp

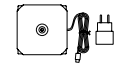
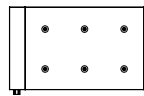
				
154	158	162	166	170
Sister Light	Tavolo Table lamp	Mini tavolo Mini table lamp	Picchetto Lamp with peg	Parete Wall lamp

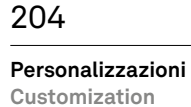
							
174	178	184	188	190	192	194	196
Pencil	Modulo luminoso con accessori Lighting module with accessories						

						
198	198	200	202	204	206	207
Accessori Accessories	Basi di ricarica e caricatori Charging bases and chargers	Basi di ricarica multipla Multi-contact charging base	Batterie Battery packs	Personalizzazioni Customization	Espositore Display unit	Indice per codice Code index

Poldina

Sembri nata dalle terre umide
mentre la vicina laguna
risplende del finire del sole.
Piccola, illumini
in un contrasto concreto e voluto
gli arbusti selvaggi e profumati.

You appear to have come from the wetlands
while the nearby lagoon
glows in the setting sun.
Little one, you illuminate
with a distinct, intentional contrast
wild and fragrant shrubs.

TAVOLO / MINI TAVOLO / MICRO TAVOLO / L DESK TAVOLO / L TERRA-TAVOLO / XXL TERRA-TAVOLO / PICCHETTO / SOSPENSIONE /
PARETE / ACCESSORI
TABLE LAMP / MINI TABLE LAMP / MICRO TABLE LAMP / L DESK TABLE LAMP / L FLOOR-TABLE LAMP / XXL FLOOR-TABLE LAMP /
LAMP WITH PEG / SUSPENSION LAMP / WALL LAMP / ACCESSORIES



Poldina lamp with peg white
→ **LD0282B3**
Porto Caleri
Rovigo, Italy



Previous page:
Poldina table lamp white → **LD0340B3**
Poldina table lamp dark grey → **LD0340N3**

Current page: Poldina XXL floor-table
lamp dark grey → **LD0360N3**
Linder Cycling Hotel - Bolzano, Italy
Photo Tiberio Sorvillo





Current page: Poldina table
lamp corten → **LD0340R3**
Natu Restaurant, Athens
Greece

Arch. Photography Giorgos Sfakianakis

Next page: Poldina mini
table lamp white → **LD0320B3**
Gran Caffè Quadri, Piazza San Marco
Venice, Italy

Photo Maurizio Torresan Photographer

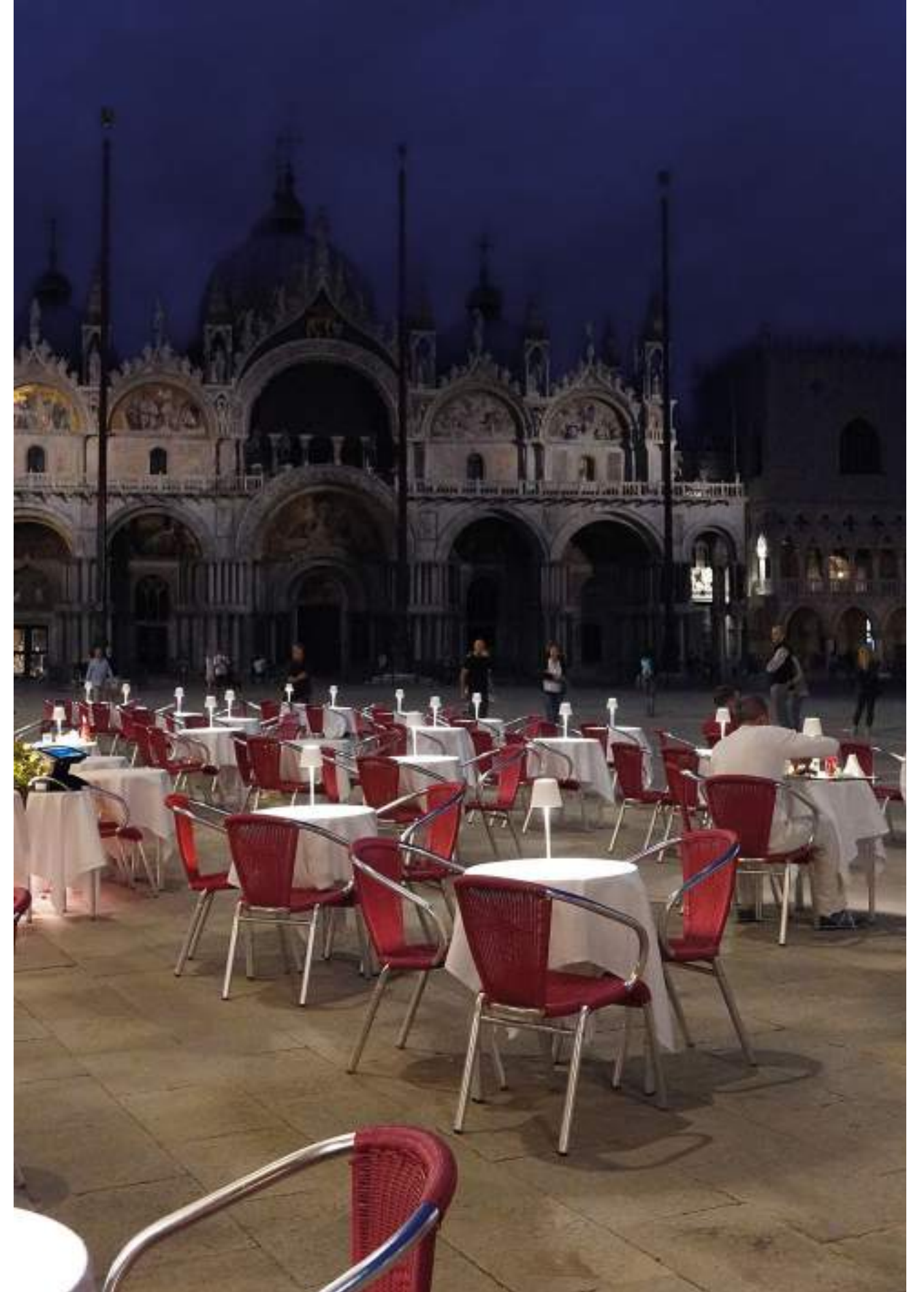

Poldina

Tavolo pro Table lamp pro



Video Poldina



Poldina è una lampada da tavolo a batteria, portatile e ricaricabile. Nella parte superiore della testa è presente un controllo "touch", che permette l'accensione, la regolazione dell'intensità luminosa e la selezione della temperatura di colore della luce tra 2200K, 2700K e 3000K. Grazie a un alto indice di protezione, la lampada è utilizzabile anche all'esterno (ad eccezione dei modelli con finitura a foglia metallica e finitura galvanica, delle quali è sconsigliato l'uso continuativo in esterni). Possiede un sistema di controllo elettronico che monitora e segnala l'autonomia residua della batteria, permettendo di ottimizzare le ricariche ed effettuarle sempre in maniera corretta. È dotata di base di ricarica a contatto; caricabatterie incluso. È possibile personalizzare la lampada con cover in ceramica, acquistabili separatamente (pag. 54).

Poldina is a rechargeable battery-powered cordless table lamp. A "touch" control on the head allows switching on/off, dimming, and selecting the color temperature of the light (2200K, 2700K or 3000K). It is suitable for both indoor and outdoor use (except gold, silver, and copper finishes). An electronic control system monitors the remaining autonomy and ensures a constant luminous flux until the battery runs out. Recharging is therefore optimized and always properly done. Poldina comes with a contact charging base; the battery charger is included. The lamp can be customized with a ceramic cover, to be purchased separately (pg. 54).

Dati tecnici Technical data

LED TOUCH DIMMER | 100-240V | 2200-2700-3000K | CRI>80 | 50-60Hz | 2,2W | 234-251-256lm | **IP65** | 5Vdc max 1A

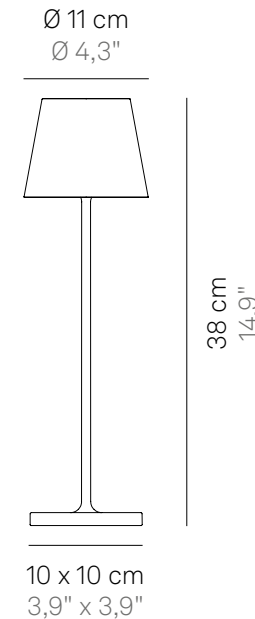

9,4 x 9,4 cm
3,7" x 3,7"

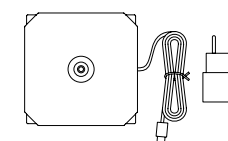

Componenti inclusi Components included

Base di ricarica a contatto
Contact charging base
Caricabatterie
Charger

Corpo in pressofusione di alluminio verniciato
Painted die-cast aluminum body

Schermo diffusore in policarbonato
Polycarbonate diffuser

Adatta all'uso esterno (lampada IP65) e interno (lampada su base di ricarica IP20) → legenda pag. 208
Suitable for outdoor (lamp IP65) and indoor use (lamp on charging base IP20) → legend pg. 208

Durata di circa 12 h alla massima potenza
Battery lasts about 12 h at full power

Tempo di ricarica a 1A: 6/7 h
Charging time at 1A: 6/7 h

Pacco batteria al litio ricaricabile e sostituibile
Rechargeable and replaceable lithium battery pack

Avvertenze Remarks

Le lampade con finitura foglia color oro, foglia color argento e foglia color rame e con finitura galvanica lucida oro e cromo non sono adatte per uso esterno. The lamps with gold color leaf, silver color leaf and copper color leaf finish and with gold and chrome glossy galvanic finish are not suitable for outdoor use.

Per effetto della natura manuale della tecnica adottata nella lavorazione con foglia metallica, l'aspetto finale della finitura delle lampade può risultare differente. Eventuali difformità attestano il pregio e l'unicità di ciascuna lampada e non vanno considerate come imperfezioni. Due to the manual nature of the technique adopted in the application of the metal foil, the final appearance of the lamps' finishing can be different. Any apparent imperfections attest to the quality and exclusivity of each lamp and should not be considered as imperfections.

Finiture
Finishes



LD0340B3
Bianco / White
RAL 9003

LD0340R3
Corten

LD0340N3
Grigio scuro / Dark grey

LD0340S3
Sabbia / Sand



LD0340X3
Bordeaux / Burgundy
RAL 3005

LD0340M3
Verde scuro / Dark green
RAL 6005

LD0340O3 *
Oro lucido
/ Glossy gold

LD0340C3 *
Cromo lucido
/ Glossy chrome

* Le lampade con finitura galvanica lucida oro e cromo non sono adatte per uso esterno e sono dotate della funzione di selezione della temperatura di colore della luce tra 2700 K e 3000 K.

* The lamps with gold and chrome glossy galvanic finish are not suitable for outdoor use and they are equipped with a light color temperature selection function 2700 K or 3000 K.

Finiture
Finishes



LD0340G3
Salvia / Sage green
Pantone 5635 U

LD0340A3
Blu avio / Avio blue
Pantone 7468 U

LD0340P3
Rosa / Pink
Pantone 698 U

LD0340F3
Rosso / Red
RAL 3000



LD0340BFO *
Foglia color oro
/ Gold color leaf

LD0340BFA *
Foglia color argento
/ Silver color leaf

LD0340RFR *
Foglia color rame
/ Copper color leaf

* Le lampade con finitura foglia color oro, foglia color argento e foglia color rame non sono adatte per uso esterno.
* The lamps with gold color leaf, silver color leaf and copper color leaf finish are not suitable for outdoor use.

poldina x PEANUTS

Tavolo pro
Table lamp pro



Poldina x Peanuts è l'edizione speciale di Poldina, lampada da tavolo a batteria portatile e ricaricabile, personalizzata con i personaggi creati da Charles Schulz. Peanuts, la striscia creata da Charles Schulz e pubblicata dal 1950, è uno dei fumetti più conosciuti al mondo. Poetici, teneri e ironici, i suoi personaggi sono figure classiche e senza tempo, in cui ogni lettore può riconoscersi.

Poldina x Peanuts is a special edition of the rechargeable battery-powered cordless table lamp Poldina, customized with characters created by Charles Schulz. Peanuts, first published in 1950, is one of the best-known comic strips in the world. Each member of the Peanuts gang is a classic, timeless figure with whom every reader can identify.

Poldina x Peanuts table lamp
Aviator → **LD0340FP1**



Dati tecnici

Technical data

LED TOUCH DIMMER | 100-240V | 2200-2700-3000K | CRI>80 | 50-60Hz | 2,2W | 234-251-256lm | **IP65** | 5Vdc max 1A



Corpo in pressofusione di alluminio verniciato

Painted die-cast aluminum body

Schermo diffusore in policarbonato

Polycarbonate diffuser

Adatta all'uso esterno (lampada IP65) e interno (lampada su base di ricarica IP20) → legenda pag. 208

Suitable for outdoor (lamp IP65) and indoor use (lamp on charging base IP20) → legend pg. 208

Durata di circa 12 h alla massima potenza

Battery lasts about 12 h at full power

Tempo di ricarica a 1A: 6/7 h

Charging time at 1A: 6/7 h

Pacco batteria al litio ricaricabile e sostituibile

Rechargeable and replaceable lithium battery pack

Ø 11 cm
Ø 4,3"

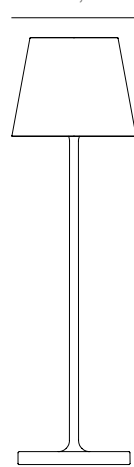

38 cm
14,9"

10 x 10 cm
3,9" x 3,9"

9,4 x 9,4 cm
3,7" x 3,7"

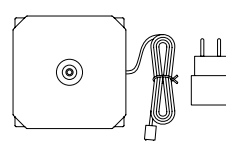
**Componenti inclusi**

Components included

Base di ricarica a contatto

Contact charging base

Caricabatterie

Charger

Finiture

Finishes

**LD0340FP1**

Aviator

RAL 3000

**LD0340BP2**

Heart

RAL 9003

**LD0340BP3**

Friends

RAL 9003

**LD0340BP4**

Strip

RAL 9003

**LD0340RP5**

Together



Poldina mini

Tavolo pro Table lamp pro



Poldina mini è una lampada da tavolo a batteria, portatile e ricaricabile. Nella parte superiore della testa è presente un controllo "touch", che permette l'accensione, la regolazione dell'intensità luminosa e la selezione della temperatura di colore della luce tra 2200K, 2700K e 3000K. Grazie a un alto indice di protezione, la lampada è utilizzabile anche all'esterno (ad eccezione dei modelli con finitura a foglia metallica e finitura galvanica, delle quali è sconsigliato l'uso continuativo in esterni). Possiede un sistema di controllo elettronico che monitora e segnala l'autonomia residua della batteria, permettendo di ottimizzare le ricariche ed effettuarle sempre in maniera corretta. È dotata di base di ricarica a contatto; caricabatterie incluso. È possibile personalizzare la lampada con cover in ceramica, acquistabili separatamente

Poldina mini is a rechargeable battery-powered cordless table lamp. A "touch" control on the head allows switching on/off, dimming, and selecting the color temperature of the light (2200K, 2700K or 3000K). It is suitable for both indoor and outdoor use (except gold, silver, and copper finishes). An electronic control system monitors the remaining autonomy and ensures a constant luminous flux until the battery runs out. Recharging is therefore optimized and always properly done. Poldina comes with a contact charging base; the battery charger is included. The lamp can be customized with a ceramic cover, to be purchased separately

Dati tecnici Technical data

LED TOUCH DIMMER | 100-240V | 2200-2700-3000K | CRI>80 | 50-60Hz | 2,2W | 234-251-256lm | **IP65** | 5Vdc max 1A

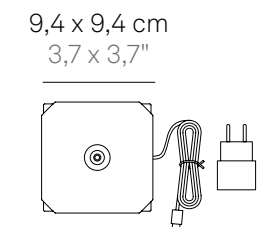
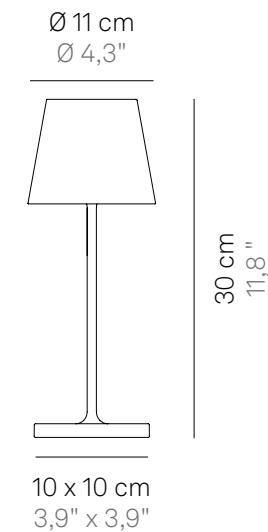

Corpo in pressofusione di alluminio verniciato
Painted die-cast aluminum body

Schermo diffusore in policarbonato
Polycarbonate diffuser

Adatta all'uso esterno (lampada IP65) e interno (lampada su base di ricarica IP20) → legenda pag. 208
Suitable for outdoor (lamp IP65) and indoor use (lamp on charging base IP20) → legend pg. 208

Durata di circa 12 h alla massima potenza
Battery lasts about 12 h at full power

Tempo di ricarica a 1A: 6/7 h
Charging time at 1A: 6/7 h

Pacco batteria al litio ricaricabile e sostituibile
Rechargeable and replaceable lithium battery pack

Avvertenze Remarks

Le lampade con finitura foglia color oro, foglia color argento e foglia color rame e con finitura galvanica lucida oro e cromo non sono adatte per uso esterno.
The lamps with gold color leaf, silver color leaf and copper color leaf finish and with gold and chrome glossy galvanic finish are not suitable for outdoor use.

Per effetto della natura manuale della tecnica adottata nella lavorazione con foglia metallica, l'aspetto finale della finitura delle lampade può risultare differente. Eventuali difformità attestano il pregio e l'unicità di ciascuna lampada e non vanno considerate come imperfezioni.

Due to the manual nature of the technique adopted in the application of the metal foil, the final appearance of the lamps' finishing can be different. Any apparent imperfections attest to the quality and exclusivity of each lamp and should not be considered as imperfections.

Componenti inclusi Components included

Base di ricarica a contatto
Contact charging base
Caricabatterie
Charger

Finiture
Finishes



LD0320B3
Bianco / White
RAL 9003

LD0320R3
Corten

LD0320N3
Grigio scuro / Dark grey

LD0320S3
Sabbia / Sand

Finiture
Finishes



LD0320BFO *
Foglia color oro
/ Gold color leaf

LD0320BFA *
Foglia color argento
/ Silver color leaf

LD0320RFR *
Foglia color rame
/ Copper color leaf



Poldina mini table
lamp dark grey
→ **LD0320N3**



LD0320O3 *
Oro lucido
/ Glossy gold

LD0320C3 *
Cromo lucido
/ Glossy chrome

* Le lampade con finitura foglia color oro, foglia color argento e foglia color rame e con finitura galvanica lucida oro e cromo non sono adatte per uso esterno. Le finiture cromate sono dotate della funzione di selezione della temperatura di colore della luce tra 2700 K e 3000 K.

* The lamps with gold color leaf, silver color leaf, copper color leaf finish and with gold and chrome glossy galvanic finish are not suitable for outdoor use. The lamps with glossy finish are equipped with a light color temperature selection function 2700 K or 3000 K.

Poldina micro

Tavolo pro Table lamp pro



Premio Barawards 2022
Innovazione dell'Anno

Barawards 2022 Innovation
of the Year Award



Poldina micro è una lampada da tavolo a batteria, portatile e ricaricabile. Nella parte superiore della testa è presente un controllo "touch", che permette l'accensione, la regolazione dell'intensità luminosa e la selezione della temperatura di colore della luce tra 2200K, 2700K e 3000K. Grazie a un alto indice di protezione, la lampada è utilizzabile anche all'esterno (ad eccezione dei modelli con finitura galvanica, delle quali è sconsigliato l'uso continuativo in esterni). Possiede un sistema di controllo elettronico che monitora e segnala l'autonomia residua della batteria, permettendo di ottimizzare le ricariche ed effettuarle sempre in maniera corretta. È dotata di base di ricarica a contatto; caricabatterie non incluso.

Poldina micro is a rechargeable battery-powered cordless table lamp. A "touch" control on the head allows switching on/off, dimming, and selecting the color temperature of the light (2200K, 2700K or 3000K). It is suitable for both indoor and outdoor use (except gold and silver finishes). An electronic control system monitors the remaining autonomy and ensures a constant luminous flux until the battery runs out. Recharging is therefore optimized and always properly done. The lamp comes with a contact charging base; the battery charger is not included.

Dati tecnici Technical data

LED TOUCH DIMMER | 2200-2700-3000K | CRI>80 | 1,8W | 174-177-195lm |
IP65 | 5 Vdc max 1A



Corpo in pressofusione di alluminio verniciato
Painted die-cast aluminum body

Schermo diffusore in policarbonato
Polycarbonate diffuser

Adatta all'uso esterno (lampada IP65) e interno (lampada su base di ricarica IP20) → legenda pag. 208
Suitable for outdoor (lamp IP65) and indoor use (lamp on charging base IP20) → legend pg. 208

Durata di circa 7/8 h alla massima potenza
Battery lasts about 7/8 h at full power

Tempo di ricarica a 1A: 3 h
Charging time at 1A: 3 h

Pacco batteria al litio ricaricabile e sostituibile
Rechargeable and replaceable lithium battery pack

Avvertenze Remarks

Le lampade con finitura galvanica lucida oro e cromo non sono adatte per uso esterno.
The lamps with gold and chrome glossy galvanic finish are not suitable for outdoor use.

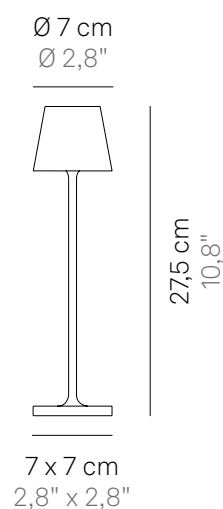

6,7 x 6,7 cm
2,6" x 2,6"

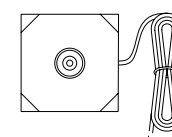

Componenti inclusi Components included

Base di ricarica a contatto
Contact charging base

Accessori non inclusi Accessories not included

Caricabatterie → pag. 199
Charger → pg. 199



Current page:
Poldina micro table lamp white → **LD0490B3**

Next page: Poldina micro
table lamp glossy gold → **LD049003**
Poldina table lamp white → **LD0340B3**



Finiture
Finishes



LD0490B3
Bianco / White
RAL 9003



LD0490R3
Corten



LD0490N3
Grigio scuro / Dark grey



LD0490D3
Nero / Black
RAL 9004



LD0490S3
Sabbia / Sand



LD0490G3
Salvia / Sage green
Pantone 5635 U



LD0490P3
Rosa / Pink
Pantone 698 U



LD0490F3
Rosso / Red
RAL 3000

Finiture
Finishes



LD0490K3
Blu Capri / Capri blue
RAL 5019



LD0490L3
Lilla / Lilac
RAL 4005



LD0490V3
Verde mela / Apple green
RAL 6018



LD0490Z3
Arancio / Orange
RAL 2008



LD0490O3 *
Oro lucido / Glossy gold



LD0490C3 *
Cromo lucido / Glossy chrome

* Le lampade con finitura galvanica lucida oro e cromo non sono adatte per uso esterno.
* The lamps with gold and chrome glossy galvanic finish are not suitable for outdoor use.

Poldina L desk

Tavolo pro Table lamp pro

NEW



Poldina L desk è una lampada da tavolo a batteria, portatile e ricaricabile. Nella parte superiore della testa è presente un controllo "touch", che permette l'accensione, la regolazione dell'intensità luminosa e la selezione della temperatura di colore della luce tra 2200K, 2700K e 3000K. Grazie a un alto indice di protezione, la lampada è utilizzabile anche all'esterno. Possiede un sistema di controllo elettronico che monitora e segnala l'autonomia residua della batteria, permettendo di ottimizzare le ricariche ed effettuarle sempre in maniera corretta. È dotata di base di ricarica a contatto; caricabatterie incluso.

Poldina L desk is a rechargeable battery-powered cordless table lamp. A "touch" control on the head allows switching on/off, dimming, and selecting the color temperature of the light (2200K, 2700K or 3000K). It is suitable for both indoor and outdoor use. An electronic control system monitors the remaining autonomy and ensures a constant luminous flux until the battery runs out. Recharging is therefore optimized and always properly done. The lamp comes with a contact charging base; the battery charger is included.

Poldina L desk table
lamp dark grey → LD0395N3



Dati tecnici

Technical data

LED TOUCH DIMMER | 100-240V | 2200-2700-3000K | CRI>80 | 50-60Hz | 5,5W | 479- 540-550lm | **IP54** | 5Vdc max 1A



Corpo in pressofusione di alluminio verniciato

Painted die-cast aluminum body

Schermo diffusore in policarbonato

Polycarbonate diffuser

Adatta all'uso esterno (lampada IP54) e interno (lampada su base di ricarica IP20) → legenda pag. 208

Suitable for outdoor (lamp IP54) and indoor use (lamp on charging base IP20) → legend pg. 208

Durata di circa 11 h alla massima potenza

Battery lasts about 11 h at full power

Tempo di ricarica a 1A: 11 h

Charging time at 1A: 11 h

Pacco batteria al litio ricaricabile e sostituibile

Rechargeable and replaceable lithium battery pack

Ø 16,5 cm
Ø 6,5"

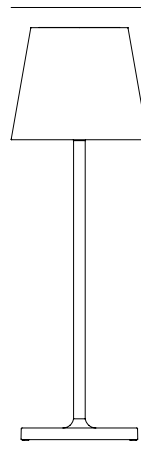

49,7 cm
19,6"

14 x 14 cm
5,5" x 5,5"

13,5 x 13,5 cm
5,3" x 5,3"

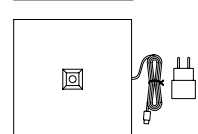
**Componenti inclusi**

Components included

Base di ricarica a contatto

Contact charging base

Caricabatterie

Charger

Finiture

Finishes

**LD0395B3**

Bianco / White

RAL 9003

LD0395R3

Corten

LD0395N3

Grigio scuro / Dark grey



Poldina L

Tavolo-terra pro Floor-table lamp pro



Poldina L è una lampada da terra e da tavolo a batteria, portatile e ricaricabile. Nella parte superiore della testa è presente un controllo "touch", che permette l'accensione, la regolazione dell'intensità luminosa e la selezione della temperatura di colore della luce tra 2200K, 2700K e 3000K. Grazie a un alto indice di protezione, la lampada è utilizzabile anche all'esterno. Possiede un sistema di controllo elettronico che monitora e segnala l'autonomia residua della batteria, permettendo di ottimizzare le ricariche ed effettuarle sempre in maniera corretta. È dotata di base di ricarica a contatto; caricabatterie incluso. È fornita con un kit di 3 aste che permette di configurarne l'altezza in tre misure: 52, 87 o 122 cm.

Poldina L is a rechargeable battery-powered cordless floor and table lamp. A "touch" control on the head allows switching on/off, dimming, and selecting the color temperature of the light (2200K, 2700K or 3000K). It is suitable for both indoor and outdoor use. An electronic control system monitors the remaining autonomy and ensures a constant luminous flux until the battery runs out. Recharging is therefore optimized and always properly done. The lamp comes with a contact charging base; the battery charger is included. It is provided with a 3-rod kit that allows to choose the height of the lamp among 52, 87 or 122 cm.

Poldina L floor-table lamp
white → **LD0390B3**



Dati tecnici

Technical data

LED TOUCH DIMMER | 100-240V | 2200-2700-3000K | CRI>80 | 50-60Hz | 5,5W | 479-540-550lm | **IP54** | 5Vdc max 1A



Ø 16,5 cm
Ø 6,5"

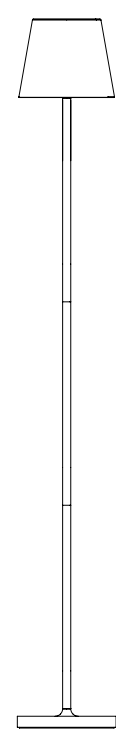

122 cm
48"

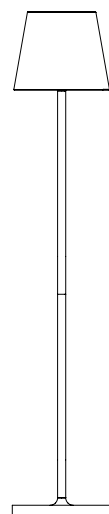

87 cm
34,2"

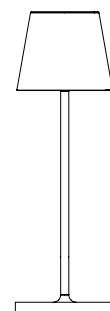

52 cm
20,4"

17 x 17 cm
6,6" x 6,6"

15 x 15 cm
5,9" x 5,9"

35 cm
13,8"

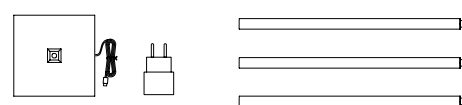

Corpo in pressofusione di alluminio verniciato
Painted die-cast aluminum body

Schermo diffusore in policarbonato
Polycarbonate diffuser

Adatta all'uso esterno (lampada IP54) e interno (lampada su base di ricarica IP20) → legenda pag. 208
Suitable for outdoor (lamp IP54) and indoor use (lamp on charging base IP20) → legend pg. 208

Durata di circa 11 h alla massima potenza
Battery lasts about 11 h at full power

Tempo di ricarica a 1A: 11 h
Charging time at 1A: 11 h

Pacco batteria al litio ricaricabile e sostituibile
Rechargeable and replaceable lithium battery pack

Finiture

Finishes

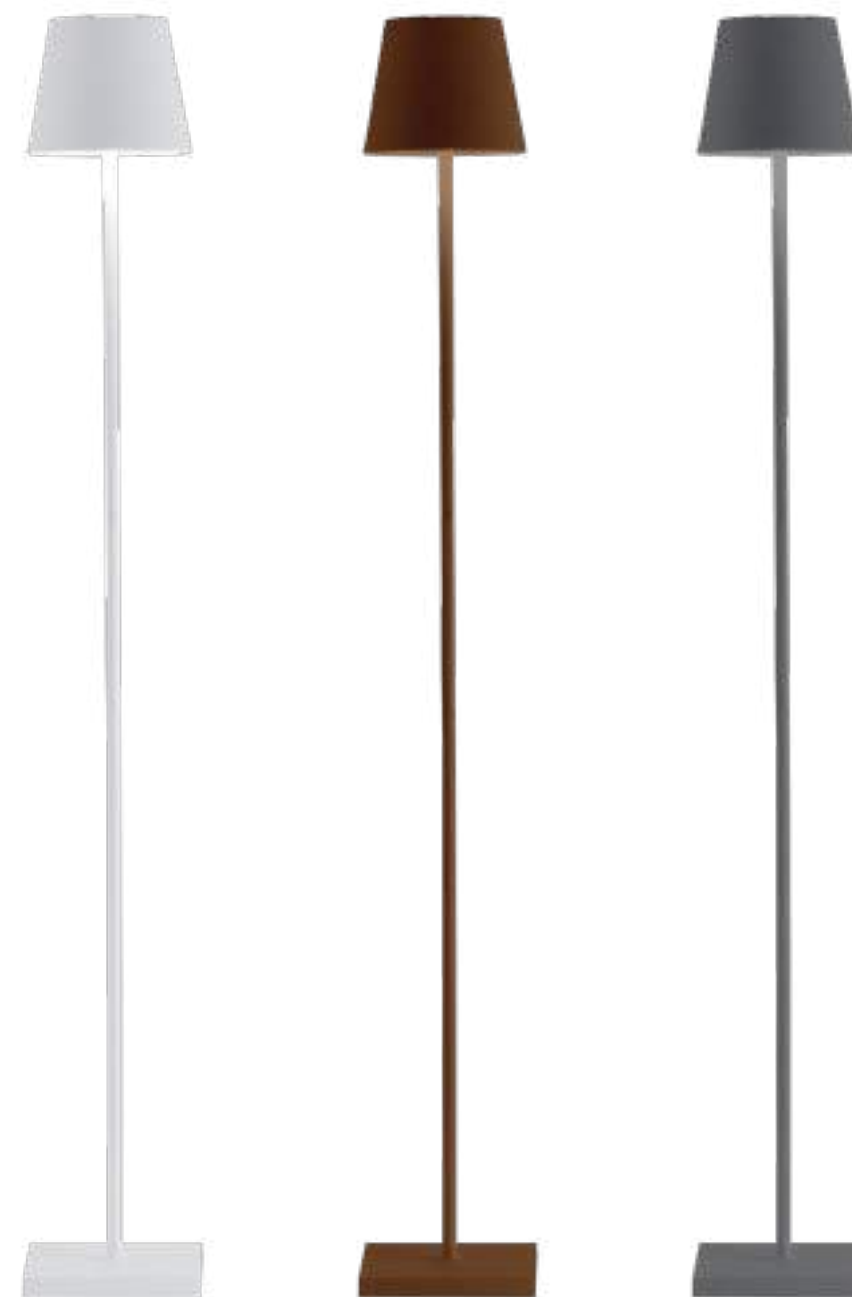

LD0390B3
Bianco / White
RAL 9003

LD0390R3
Corten

LD0390N3
Grigio scuro / Dark grey

Componenti inclusi

Components included

Base di ricarica a contatto
Contact charging base

Caricabatterie
Charger

Stelo (3 pz.)
Stem (3 pcs.)

Poldina XXL

Tavolo-terra pro Floor-table lamp pro



Poldina XXL è una lampada da terra e da tavolo a batteria, portatile e ricaricabile. Nella parte superiore dello stelo è presente un controllo "touch", che permette l'accensione, la regolazione dell'intensità luminosa e la selezione della temperatura di colore della luce tra 2700K e 3000K. Grazie a un alto indice di protezione, la lampada è utilizzabile anche all'esterno. È dotata di base di ricarica a contatto; caricabatterie incluso. È fornita con un kit di 3 aste che permette di configurarne l'altezza in tre misure: 69, 110 o 150 cm.

Poldina XXL is a rechargeable battery-powered cordless floor and table lamp. A "touch" control on the upper part of the stem allows switching on/off, dimming, and selecting the color temperature of the light (2700K or 3000K). It is suitable for both indoor and outdoor use. The lamp comes with a contact charging base; the battery charger is included. It is provided with a 3-rod kit that allows to choose the height of the lamp among 69, 110 or 150 cm.



Poldina XXL floor-table lamp
dark grey → **LD0360N3**

Dati tecnici

Technical data

LED TOUCH DIMMER | 100-240V |
2700-3000K | CRI>80 | 50-60Hz | 6,5W |
470-500lm | **IP54** | 5Vdc max 1A



Ø 28 cm
Ø 11"

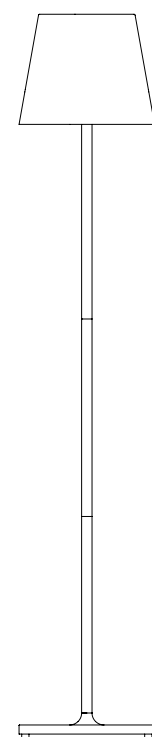

150 cm
59"

28 x 28 cm
11" x 11"

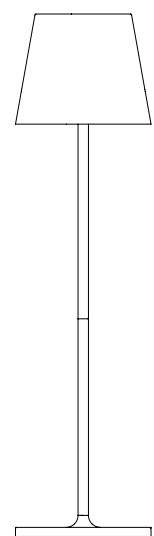

110 cm
43,3"

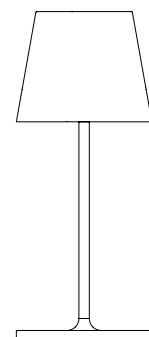

69,5 cm
27,3"

Ø 24,7 cm
Ø 9,7"

40 cm
15,7"

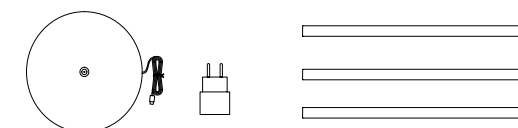

Corpo in pressofusione di alluminio verniciato
Painted die-cast aluminum body

Schermo diffusore in policarbonato
Polycarbonate diffuser

Adatta all'uso esterno (lampada IP54) e interno
(lampada su base di ricarica IP20) → legenda pag. 208
Suitable for outdoor (lamp IP54) and indoor use
(lamp on charging base IP20) → legend pg. 208

Durata di circa 15 h alla massima potenza
Battery lasts about 15 h at full power

Tempo di ricarica a 1A: 20 h
Charging time at 1A: 20 h

Pacco batteria al litio ricaricabile e sostituibile
Rechargeable and replaceable lithium battery pack

Finiture

Finishes



LD0360B3
Bianco / White
RAL 9003

LD0360R3
Corten

LD0360N3
Grigio scuro / Dark grey

Componenti inclusi

Components included

Base di ricarica a contatto
Contact charging base

Caricabatterie
Charger

Stelo (3 pz.)
Stem (3 pcs.)

Poldina

Picchetto pro

Lamp with peg pro



Poldina è una lampada a batteria, portatile e ricaricabile con picchetto. Nella parte superiore della testa è presente un controllo "touch", che permette l'accensione, la regolazione dell'intensità luminosa e la selezione della temperatura di colore della luce tra 2200K, 2700K e 3000K. Grazie a un alto indice di protezione, la lampada è utilizzabile anche all'esterno. Possiede un sistema di controllo elettronico che monitora e segnala l'autonomia residua della batteria, permettendo di ottimizzare le ricariche ed effettuarle sempre in maniera corretta. È dotata di testa magnetica che si rimuove in modo pratico e si ricarica comodamente sulla propria base di ricarica a contatto; caricabatterie incluso. È possibile personalizzare la lampada con cover in ceramica, acquistabili separatamente. Come accessori, sono disponibili aste aggiuntive che permettono di aumentare l'altezza della lampada.

Poldina is a rechargeable battery-powered cordless lamp with peg. A "touch" control on the head allows switching on/off, dimming, and selecting the color temperature of the light (2200K, 2700K or 3000K). It is suitable for both indoor and outdoor use. An electronic control system monitors the remaining autonomy and ensures a constant luminous flux until the battery runs out. Recharging is therefore optimized and always properly done. The lamp comes with magnetic head, which can be removed easily and recharged conveniently on their own contact charging base; the battery charger is included. It can be customized with a ceramic cover, to be purchased separately. Additional stem extensions are available as accessories to increase the height of the lamp (to be purchased separately).



Poldina lamp with peg white → **LD0682B3**

Dati tecnici

Technical data

LED TOUCH DIMMER | 100-240V | 2200-2700-3000K | CRI>80 | 50-60Hz | 2,2W | 234-251-256lm | **IP54** | 5Vdc max 1A



Corpo in pressofusione di alluminio verniciato

Painted die-cast aluminum body

Schermo diffusore in policarbonato

Polycarbonate diffuser

Adatta all'uso esterno (lampada IP54) e interno (lampada su base di ricarica IP20) → legenda pag. 208

Suitable for outdoor (lamp IP54) and indoor use (lamp on charging base IP20) → legend pg. 208

Durata di circa 9 h alla massima potenza

Battery lasts about 9 h at full power

Tempo di ricarica a 1A: 6 h

Charging time at 1A: 6 h

Pacco batteria al litio ricaricabile e sostituibile

Rechargeable and replaceable lithium battery pack

Avvertenze

Remarks

La stabilità della lampada è garantita con l'uso di massimo tre prolunghe

The stability of the lamp is guaranteed when using three extensions maximum

Ø 11 cm
Ø 4,3"

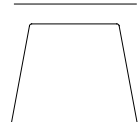

60 cm
23,6"

Ø 1,2 cm
Ø 0,4"

Ø 10,2 cm
Ø 4"

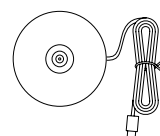
**Componenti inclusi**

Components included

Base di ricarica a contatto

Contact charging base

Accessori non inclusi

Accessories not included

Caricabatterie → pag. 199

Charger → pg. 199

Prolunga stelo aggiuntiva → pag. 45

Additional stem extension → pg. 45

Finiture

Finishes

**LD0682B3**

Bianco / White

RAL 9003

LD0682R3

Corten

LD0682N3

Grigio scuro / Dark grey

Prolunga stelo aggiuntiva (non inclusa)

Additional stem extension (not included)

25 cm
9,8"



25 cm
9,8"



25 cm
9,8"

**LD0283B3**

Bianco / White

RAL 9003

LD0283R3

Corten

LD0283N3

Grigio scuro / Dark grey

Poldina

Sospensione pro Suspension lamp pro



Poldina è una lampada a batteria, portatile e ricaricabile a sospensione. Nella parte superiore della testa è presente un controllo "touch", che permette l'accensione, la regolazione dell'intensità luminosa e la selezione della temperatura di colore della luce tra 2200K, 2700K e 3000K. Grazie a un alto indice di protezione, la lampada è utilizzabile anche all'esterno. Possiede un sistema di controllo elettronico che monitora e segnala l'autonomia residua della batteria, permettendo di ottimizzare le ricariche ed effettuarle sempre in maniera corretta. È dotata di testa magnetica che si rimuove in modo pratico e si ricarica comodamente sulla propria base di ricarica a contatto; caricabatterie incluso. È possibile personalizzare la lampada con cover in ceramica, acquistabili separatamente.

Poldina is a rechargeable battery-powered cordless suspension lamp. A "touch" control on the head allows switching on/off, dimming, and selecting the color temperature of the light (2200K, 2700K or 3000K). It is suitable for both indoor and outdoor use. An electronic control system monitors the remaining autonomy and ensures a constant luminous flux until the battery runs out. Recharging is therefore optimized and always properly done. The lamp comes with magnetic head, which can be removed easily and recharged conveniently on their own contact charging base; the battery charger is included. It can be customized with a ceramic cover, to be purchased separately.

Poldina suspension lamp
white → **LD0686B3**



Dati tecnici

Technical data

LED TOUCH DIMMER | 100-240V | 2200-2700-3000K | CRI>80 | 50-60Hz | 2,2W | 234-251-256lm | **IP54** | 5Vdc max 1A



Corpo in pressofusione di alluminio verniciato

Painted die-cast aluminum body

Schermo diffusore in policarbonato

Polycarbonate diffuser

Adatta all'uso esterno (lampada IP54) e interno (lampada su base di ricarica IP20) → legenda pag. 208

Suitable for outdoor (lamp IP54) and indoor use (lamp on charging base IP20) → legend pg. 208

Durata di circa 9 h alla massima potenza

Battery lasts about 9 h at full power

Tempo di ricarica a 1A: 6 h

Charging time at 1A: 6 h

Pacco batteria al litio ricaricabile e sostituibile

Rechargeable and replaceable lithium battery pack

Ø 11 cm
Ø 4,3"

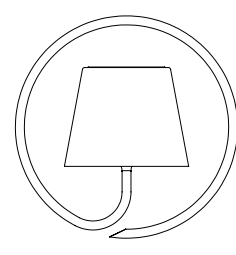

19,8 cm
7,8"

19,8 cm
7,8"

Ø 10,2 cm
Ø 4"

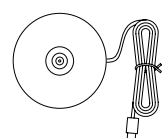
**Componenti inclusi**

Components included

Base di ricarica a contatto
Contact charging base

Accessori non inclusi

Accessories not included

Caricabatterie → pag. 199
Charger → pg. 199

Finiture

Finishes

**LD0686B3**

Bianco / White
RAL 9003

LD0686R3

Corten

LD0686N3

Grigio scuro / Dark grey



Poldina suspension lamp
corten → **LD0686R3**

Poldina

Parete pro Wall lamp pro



Poldina è una lampada a batteria, portatile e ricaricabile da parete, disponibile in due versioni. Nella parte superiore della testa è presente un controllo "touch", che permette l'accensione, la regolazione dell'intensità luminosa e la selezione della temperatura di colore della luce tra 2200K, 2700K e 3000K. Grazie a un alto indice di protezione, la lampada è utilizzabile anche all'esterno. Possiede un sistema di controllo elettronico che monitora e segnala l'autonomia residua della batteria, permettendo di ottimizzare le ricariche ed effettuarle sempre in maniera corretta. È dotata di testa magnetica che si rimuove in modo pratico e si ricarica comodamente sulla propria base di ricarica a contatto; caricabatterie incluso. È possibile personalizzare la lampada con cover in ceramica, acquistabili separatamente.

Poldina is a rechargeable battery-powered cordless wall lamp. A "touch" control on the head allows switching on/off, dimming, and selecting the color temperature of the light (2200K, 2700K or 3000K). It is suitable for both indoor and outdoor use. An electronic control system monitors the remaining autonomy and ensures a constant luminous flux until the battery runs out. Recharging is therefore optimized and always properly done. The lamp comes with magnetic head, which can be removed easily and recharged conveniently on their own contact charging base; the battery charger is included. It can be customized with a ceramic cover, to be purchased separately.



Poldina wall lamp dark grey
→ LD0688N3

Dati tecnici

Technical data

LED TOUCH DIMMER | 100-240V | 2200-2700-3000K | CRI>80 | 50-60Hz | 2,2W | 234-251-256lm | **IP54** | 5Vdc max 1A



Corpo in pressofusione di alluminio verniciato

Painted die-cast aluminum body

Schermo diffusore in policarbonato

Polycarbonate diffuser

Adatta all'uso esterno (lampada IP54) e interno (lampada su base di ricarica IP20) → legenda pag. 208

Suitable for outdoor (lamp IP54) and indoor use (lamp on charging base IP20) → legend pg. 208

Durata di circa 9 h alla massima potenza

Battery lasts about 9 h at full power

Tempo di ricarica a 1A: 6 h

Charging time at 1A: 6 h

Pacco batteria al litio ricaricabile e sostituibile

Rechargeable and replaceable lithium battery pack

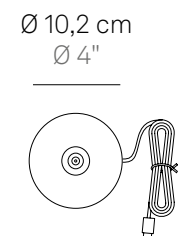
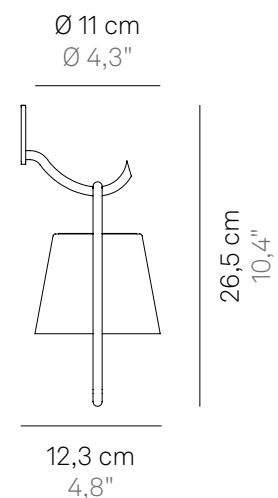
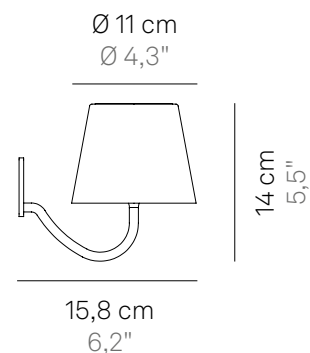

Componenti inclusi

Components included

Base di ricarica a contatto
Contact charging base

Accessori non inclusi

Accessories not included

Caricabatterie → pag. 199
Charger → pg. 199

Finiture

Finishes



LD0688B3
Bianco / White
RAL 9003



LD0688R3
Corten



LD0688N3
Grigio scuro / Dark grey



LD0689B3
Bianco / White
RAL 9003



LD0689R3
Corten



LD0689N3
Grigio scuro / Dark grey

Poldina

Cover in ceramica made in Italy

Ceramic cover made in Italy

NEW

Accessorio per / Accessory for:
 Poldina table lamp (pg. 12)
 Poldina mini table lamp (pg. 20)
 Poldina lamp with peg (pg. 42)
 Poldina suspension lamp (pg. 46)
 Poldina wall lamp (pg. 50)
 Poldina Reverso table lamp (pg. 60)



Dati tecnici

Technical data

CE

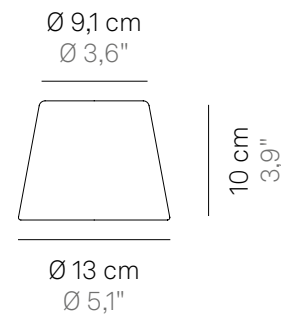

Componenti inclusi
 Components included

Magnete
 Magnet

Video tutorial: montaggio cover
 Tutorial video: installation of the cover



Cover in ceramica che si fissa alla testa della lampada Poldina tramite adesivi. La stretta collaborazione con un'antica fabbrica di Civita Castellana - borgo viterbese dove l'arte della ceramica è attestata fin dal X secolo a.C. - consente a Zafferano di avvalersi di una produzione esclusiva di manufatti "Made in Italy", decorati a mano su disegno proprio o del cliente.

Ceramic cover that is fixed to the head of the lamp with adhesive strips. The close partnership with a historic factory in Civita Castellana - a village near Rome, where the art of ceramics has been practiced since the 10th century BC - allows Zafferano to rely on the exclusive production of made in Italy artifacts, which are hand-painted according to Zafferano design; customization available.

Finiture
 Finishes



LD035000
 Righe verdi
 Green stripes



LD035001
 Righe gialle
 Yellow stripes



LD035002
 Righe blu
 Blue stripes



LD035003
 Righe rosse
 Red stripes



LD035004
 Pesci azzurri
 Light blue fish



Poldina table lamp Avio blue → **LD0340A3**
 Ceramic cover → **LD035004**



Poldina wall lamp white + ceramic cover
→ **LD0340B3 + LD035000**



Poldina Reverso

Design Federico de Majo

Come sono belli e delicati
i piccoli fiori del tuo davanzale.
Se illuminati i loro colori
si trasformano in cristalli: dolci e salati,
diventano un piccolo tesoro
o le chiavi della felicità.

What beautiful, tiny and
delicate flowers on your windowsill.
When illuminated their colours
turn into crystals: sweet and savoury,
they become a little treasure
or the keys to happiness.

TAVOLO
TABLE LAMP



Poldina Reverso table
lamp white → **LD0420B3**
Porto Caleri
Rovigo, Italy

Poldina Reverso

Tavolo pro Table lamp pro

NEW



Video Poldina Reverso

Poldina Reverso è una lampada da tavolo a batteria, portatile e ricaricabile, con contenitore multiuso. Nella parte inferiore della testa è presente un controllo "touch", che permette l'accensione, la regolazione dell'intensità luminosa e la selezione della temperatura di colore della luce tra 2200K, 2700K e 3000K. Grazie a un alto indice di protezione, la lampada è utilizzabile anche all'esterno. Il contenitore multiuso (capacità 18 cl) in resina termoplastica adatta al contatto alimentare (PET) è removibile e riutilizzabile. Possiede un sistema di controllo elettronico che monitora e segnala l'autonomia residua della batteria, permettendo di ottimizzare le ricariche ed effettuarle sempre in maniera corretta. È dotata di base di ricarica a contatto; caricabatterie incluso. È possibile personalizzare la lampada con cover in ceramica, acquistabili separatamente



Poldina Reverso is a rechargeable battery-powered cordless table lamp, with a multipurpose storage tray. A "touch" control smartly placed on the lower part of the head allows switching on/off, dimming, and selecting the color temperature of the light (2200K, 2700K or 3000K). It is suitable for both indoor and outdoor use. The multipurpose container tray (capacity 18cl) in thermoplastic resin suitable for food contact (PET) is removable and reusable. An electronic control system monitors the remaining autonomy and ensures a constant luminous flux until the battery runs out. Recharging is therefore optimized and always properly done. The lamp comes with a contact charging base; battery charger included. Poldina Reverso can be customized with a ceramic cover, to be purchased separately

Poldina Reverso table lamp
white → LD0420B3







Poldina Reverso table lamp
sage green → **LD0420G3**



Poldina Reverso table lamp
dark grey → **LD0420N3**



Pulsante touch per l'accensione e dimmerazione
Touch switch for on/off and dimming

Vaschetta contenitore multiuso
(adatto anche per uso alimentare)
Multipurpose container tray (suitable also for food)
→ **LD0420V1**



Poldina Reverso table
lamp corten → **LD0420R3**



Dati tecnici

Technical data

LED TOUCH DIMMER | 100-240V | 2200-2700-3000K | CRI>80 | 50-60Hz | 2,3W | 241-250-262lm | **IP54** | 5Vdc max 1A

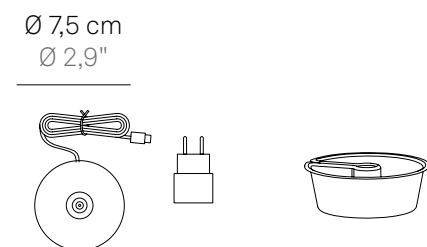
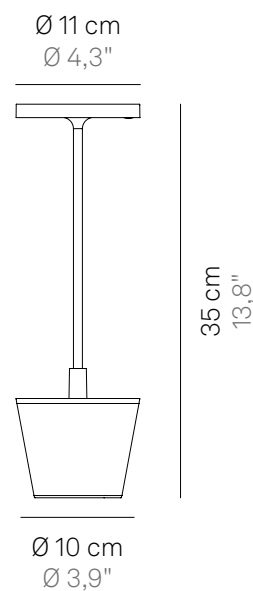

Corpo in pressofusione di alluminio verniciato
Painted die-cast aluminum body

Schermo diffusore in policarbonato satinato
Diffuser in satin-finish polycarbonate

Adatta all'uso esterno (lampada IP54) e interno (lampada su base di ricarica IP20) → legenda pag. 208
Suitable for outdoor (lamp IP54) and indoor use (lamp on charging base IP20) → legend pg. 208

Durata di circa 12 h alla massima potenza
Battery lasts about 12 h at full power

Tempo di ricarica a 1A: 6/7 h
Charging time at 1A: 6/7 h

Pacco batteria al litio ricaricabile e sostituibile
Rechargeable and replaceable lithium battery pack

Componenti inclusi

Components included

Base di ricarica a contatto
Contact charging base

Caricabatterie
Charger

Vaschetta contenitore multiuso
Multipurpose container tray

Finiture

Finishes



LD0420B3
Bianco / White
RAL 9003



LD0420R3
Corten



LD0420N3
Grigio scuro / Dark grey



LD0420S3
Sabbia / Sand



LD0420G3
Salvia / Sage green
Pantone 5635 U

Ofelia

Edera, forte, intensa
Giunte dopo un lungo errare
Uniamo le nostre radici
In un intimo cercarsi.

Ivy, strong and intense
arriving after a long ramble
we merge our roots
in an intimate search.

TAVOLO
TABLE LAMP



Ofelia table lamp white
→ **LD1870B3**
Storga river springs
Treviso, Italy



Ofelia table lamp sage
green → **LD1870G3**
Ristorante Piastrino *
Pennabilli, Italy
Photo Marco Poderi Studio

Ofelia table lamp
sand → **LD1870S3**
Ristorante Oltre
Leporano, Italy
Photo Giuseppe Musolino



Ofelia

Tavolo pro

Table lamp pro



Ofelia è una lampada da tavolo a batteria, portatile e ricaricabile. Nella parte superiore della testa è presente un controllo "touch", che permette l'accensione, la regolazione dell'intensità luminosa e la selezione della temperatura di colore della luce tra 2200K, 2700K e 3000K. Ofelia possiede inoltre la funzione di memoria dell'impostazione di dimmerazione, che memorizza gli step di dimmerazione: di conseguenza, ad ogni accensione, l'intensità luminosa corrisponderà a quella precedentemente impostata. Grazie a un alto indice di protezione, la lampada è utilizzabile anche all'esterno. È dotata di base di ricarica a contatto; caricabatterie incluso.

Ofelia is a rechargeable battery-powered cordless table lamp. A "touch" control on the head allows switching on/off, dimming, and selecting the color temperature of the light (2200K, 2700K or 3000K). Ofelia is equipped with the dimmer memory function, which adjusts the light intensity and memorizes the dimmer steps; consequently, every time it is switched on, the light intensity will correspond to that previously set. It is suitable for both indoor and outdoor use. The lamp comes with a contact charging base; battery charger included.

Ofelia table lamp sage green
→ LD1870G3



Dati tecnici

Technical data

LED TOUCH DIMMER | 100-240V |
2200-2700-3000K | CRI>80 | 50-60Hz |
2,2W | 231-244-252lm | **IP65** | 5Vdc max 1A



Corpo in pressofusione di alluminio verniciato
Painted die-cast aluminum body

Schermo diffusore in policarbonato prismatico
Prismatic polycarbonate diffuser

Adatta all'uso esterno (lampada IP65) e interno
(lampada su base di ricarica IP20) → legenda pag. 208
Suitable for outdoor (lamp IP65) and indoor use
(lamp on charging base IP20) → legend pg. 208

Durata di circa 9 h alla massima potenza
Battery lasts about 9 h at full power

Tempo di ricarica a 1A: 6 h
Charging time at 1A: 6 h

Pacco batteria al litio ricaricabile e sostituibile
Rechargeable and replaceable lithium battery pack

10 x 10 cm
3,9 x 3,9"

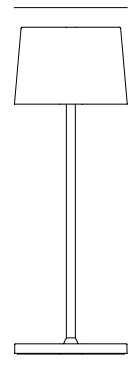

29 cm
11,4"

10 x 10 cm
3,9" x 3,9"

11,6 x 11,6 cm
4,5" x 4,5"

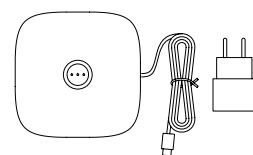
**Componenti inclusi**

Components included

Base di ricarica a contatto
Contact charging base

Caricabatterie
Charger

Finiture

Finishes



LD1870B3
Bianco / White
RAL 9016



LD1870R3
Corten



LD1870N3
Grigio scuro / Dark grey
RAL 7024



LD1870S3
Sabbia / Sand
RAL 1014



LD1870G3
Salvia / Sage green
Pantone 5635U

Olivia

We are the custodians
of a pure stone manor
with its strong presence
and hard, rugged rock.
Illuminated, it is softened
and when night falls
we keep vigil motionless.

Siamo custodi
di un maniero di pura pietra
forte presenza
roccia dura ed aspra.
Illuminata si addolcisce
scesa la notte
vegliamo immobili.

TAVOLO / MINI TAVOLO
TABLE LAMP / MINI TABLE LAMP



Olivia table lamp white
→ **LD0850B3**
Caglieron Caves
Treviso, Italy



Olivia table lamp
corten → **LD0850R3**
A Cavalariça
Évora, Portugal
Photo Francisco Nogueira



Olivia mini table lamp orange → **LD0860Z3**
Olivia mini table lamp Capri blue → **LD0860K3**
Olivia mini table lamp apple green → **LD0860V3**

Olivia

Tavolo pro

Table lamp pro



Olivia è una lampada da tavolo a batteria, portatile e ricaricabile. Nella parte superiore della testa è presente un controllo "touch", che permette l'accensione, la regolazione dell'intensità luminosa e la selezione della temperatura di colore della luce tra 2700K e 3000K. Olivia possiede inoltre la funzione di memoria dell'impostazione di dimmerazione, che memorizza gli step di dimmerazione: di conseguenza, ad ogni accensione, l'intensità luminosa corrisponderà a quella precedentemente impostata. Grazie a un alto indice di protezione, la lampada è utilizzabile anche all'esterno (ad eccezione dei modelli con finitura a foglia metallica, delle quali è sconsigliato l'uso continuativo in esterni). È dotata di base di ricarica a contatto; caricabatterie incluso.

Olivia is a rechargeable battery-powered cordless table lamp. A "touch" control on the head allows switching on/off, dimming, and selecting the color temperature of the light (2700K or 3000K). Olivia is equipped with the dimmer memory function, which adjusts the light intensity and memorizes the dimmer steps; consequently, every time it is switched on, the light intensity will correspond to that previously set. It is suitable for both indoor and outdoor use (except gold, silver and copper finishes). The lamp comes with a contact charging base; battery charger included.



Olivia table lamp corten → LD0850R3

Dati tecnici

Technical data

LED TOUCH DIMMER | 100-240V |
2700-3000K | CRI>80 | 50-60Hz | 2,2W |
245-262lm | **IP65** | 5Vdc max 1A



Corpo in pressofusione di alluminio verniciato
Painted die-cast aluminum body

Schermo diffusore in policarbonato prismatico
Prismatic polycarbonate diffuser

Adatta all'uso esterno (lampada IP65) e interno
(lampada su base di ricarica IP20) → legenda pag. 208
Suitable for outdoor (lamp IP65) and indoor use
(lamp on charging base IP20) → legend pg. 208

Durata di circa 9 h alla massima potenza
Battery lasts about 9 h at full power

Tempo di ricarica a 1A: 6 h
Charging time at 1A: 6 h

Pacco batteria al litio ricaricabile e sostituibile
Rechargeable and replaceable lithium battery pack

Avvertenze

Remarks

Le lampade con finitura foglia color oro, foglia color argento e foglia color rame non sono adatte per uso esterno.
The lamps with gold color leaf, silver color leaf and copper color leaf finish are not suitable for outdoor use.

Per effetto della natura manuale della tecnica adottata nella lavorazione con foglia metallica, l'aspetto finale della finitura delle lampade può risultare differente. Eventuali difformità attestano il pregio e l'unicità di ciascuna lampada e non vanno considerate come imperfezioni.

Due to the manual nature of the technique adopted in the application of the metal foil, the final appearance of the lamps' finishing can be different. Any apparent imperfections attest to the quality and exclusivity of each lamp and should not be considered as imperfections.

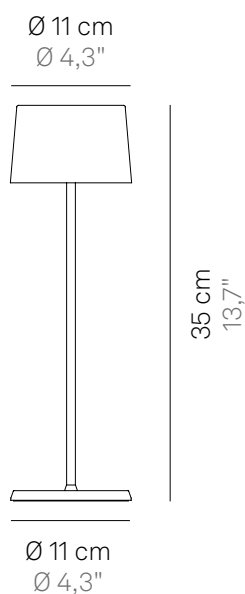

Ø 11,6 cm
Ø 4,5"

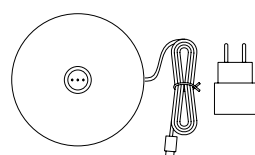
**Componenti inclusi**

Components included

Base di ricarica a contatto
Contact charging base

Caricabatterie
Charger

Finiture

Finishes



LD0850B3
Bianco / White
RAL 9016



LD0850R3
Corten



LD0850N3
Grigio scuro / Dark grey
RAL 7012



LD0850BFO *
Foglia color oro
/ Gold color leaf



LD0850BFA *
Foglia color argento
/ Silver color leaf



LD0850RFR *
Foglia color rame
/ Copper color leaf

* Le lampade con finitura foglia color oro, foglia color argento e foglia color rame non sono adatte per uso esterno.
* The lamps with gold color leaf, silver color leaf and copper color leaf finish are not suitable for outdoor use.

Olivia mini

Tavolo pro

Table lamp pro



Olivia mini è una lampada da tavolo a batteria, portatile e ricaricabile. Nella parte superiore della testa è presente un controllo "touch", che permette l'accensione, la regolazione dell'intensità luminosa e la selezione della temperatura di colore della luce tra 2700K e 3000K. Olivia mini possiede inoltre la funzione di memoria dell'impostazione di dimmerazione, che memorizza gli step di dimmerazione: di conseguenza, ad ogni accensione, l'intensità luminosa corrisponderà a quella precedentemente impostata. Grazie a un alto indice di protezione, la lampada è utilizzabile anche all'esterno. È dotata di base di ricarica a contatto; caricabatterie incluso.

Olivia mini is a rechargeable battery-powered cordless table lamp. A "touch" control on the head allows switching on/off, dimming, and selecting the color temperature of the light (2700K or 3000K). Olivia mini is equipped with the dimmer memory function, which adjusts the light intensity and memorizes the dimmer steps; consequently, every time it is switched on, the light intensity will correspond to that previously set. It is suitable for both indoor and outdoor use. The lamp comes with a contact charging base; battery charger included.



Olivia mini table lamp corten
→ **LD0860R3**

Dati tecnici

Technical data

LED TOUCH DIMMER | 100-240V |
2700-3000K | CRI>80 | 50-60Hz | 2,2W |
245-262lm | **IP65** | 5Vdc max 1A



Corpo in pressofusione di alluminio verniciato
Painted die-cast aluminum body

Schermo diffusore in policarbonato prismatico
Prismatic polycarbonate diffuser

Adatta all'uso esterno (lampada IP65) e interno
(lampada su base di ricarica IP20) → legenda pag. 208
Suitable for outdoor (lamp IP65) and indoor use
(lamp on charging base IP20) → legend pg. 208

Durata di circa 9 h alla massima potenza
Battery lasts about 9 h at full power

Tempo di ricarica a 1A: 6 h
Charging time at 1A: 6 h

Pacco batteria al litio ricaricabile e sostituibile
Rechargeable and replaceable lithium battery pack

Ø 11 cm
Ø 4,3"

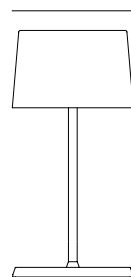

22 cm
8,7"

Ø 11 cm
Ø 4,3"

Ø 11,6 cm
Ø 4,5"

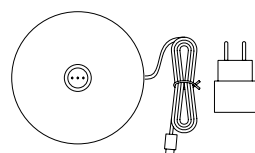
**Componenti inclusi**

Components included

Base di ricarica a contatto
Contact charging base

Caricabatterie
Charger

Finiture

Finishes



LD0860B3
Bianco / White
RAL 9016



LD0860R3
Corten



LD0860N3
Grigio scuro / Dark grey
RAL 7012



LD0860K3
Blu Capri / Capri blue
RAL 5019



LD0860L3
Lilla / Lilac
RAL 4005



LD0860V3
Verde mela / Apple green
RAL 6018



LD0860Z3
Arancio / Orange
RAL 2008

Pina

Piccola, docile
mobile e leggera
ti annidi e ti confondi.
Gioca la luce
offre dettagli dimenticati.

Small, gentle
mobile and light
you hide and blend in.
Light brings playful effects
offering forgotten details.

TAVOLO / SUPPORTO DA TERRA / VASSOIO IN CERAMICA
TABLE LAMP / FLOOR STAND / CERAMIC TRAY



Pina table lamp white → **LD1650B3**
Morgano countryside
Treviso, Italy



Previous page: Pina table lamp corten →
LD1650R3
 Cipriani Club 55 - New York City, USA

Current page: Pina table lamp corten →
LD1650R3
 Cipriani Downtown - New York City, USA
 Photo Kathi Littwin Photography

Pina

Tavolo pro Table lamp pro



Pina nel New York Times
Pina in New York Times



Pina è una lampada da tavolo a batteria, portatile e ricaricabile. Sulla base è presente un controllo “touch”, che permette l'accensione, la regolazione dell'intensità luminosa e la selezione della temperatura di colore della luce tra 2200K, 2700K e 3000K. Grazie a un alto indice di protezione, la lampada è utilizzabile anche all'esterno (ad eccezione dei modelli con finitura a foglia metallica, delle quali è sconsigliato l'uso continuativo in esterni). Possiede un sistema di controllo elettronico che monitora e segnala l'autonomia residua della batteria, permettendo di ottimizzare le ricariche ed effettuarle sempre in maniera corretta. È dotata di base di ricarica a contatto; caricabatterie incluso. Pina è personalizzabile con il supporto da terra o con il vassoio in ceramica, acquistabili separatamente (pag.98 e pag. 102).

Pina is a rechargeable battery-powered cordless table lamp. A "touch" control on the head allows switching on/off, dimming, and selecting the color temperature of the light (2200 K, 2700 K or 3000 K). It is suitable for both indoor and outdoor use (except gold, silver and copper finishes). An electronic control system monitors the remaining autonomy and ensures a constant luminous flux until the battery runs out. Recharging is therefore optimized and always properly done. The lamp comes with a contact charging base; battery charger included. Pina can be accessorized with a floor stand or a ceramic tray, to be purchased separately (pg. 98 and pg.102).

Pina table lamp white
→ LD1650B3



Dati tecnici

Technical data

LED TOUCH DIMMER | 100-240V |
2200-2700-3000K | CRI>80 | 50-60Hz |
2,2W | 178-204-206lm | **IP54** | 5Vdc max 1A



Corpo in pressofusione di alluminio verniciato

Painted die-cast aluminum body

Schermo diffusore in policarbonato

Polycarbonate diffuser

Adatta all'uso esterno (lampada IP54) e interno
(lampada su base di ricarica IP20) → legenda pag. 208

Suitable for outdoor (lamp IP54) and indoor use
(lamp on charging base IP20) → legend pg. 208

Durata di circa 12 h alla massima potenza

Battery lasts about 12 h at full power

Tempo di ricarica a 1A: 6/7 h

Charging time at 1A: 6/7 h

Pacco batteria al litio ricaricabile e sostituibile

Rechargeable and replaceable lithium battery pack

Avvertenze

Remarks

Le lampade con finitura foglia color oro, foglia color
argento e foglia color rame non sono adatte per uso
esterno.

The lamps with gold color leaf, silver color leaf and
copper color leaf finish are not suitable for outdoor use.

Per effetto della natura manuale della tecnica adottata
nella lavorazione con foglia metallica, l'aspetto finale
della finitura delle lampade può risultare differente.
Eventuali difformità attestano il pregio e l'unicità di
ciascuna lampada e non vanno considerate come
imperfezioni.

Due to the manual nature of the technique adopted in
the application of the metal foil, the final appearance
of the lamps' finishing can be different. Any apparent
imperfections attest to the quality and exclusivity
of each lamp and should not be considered as
imperfections.

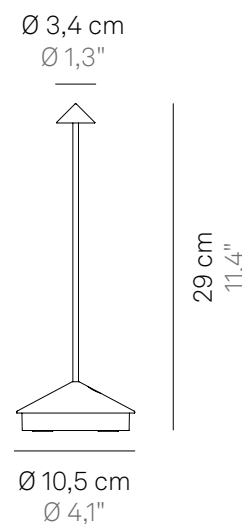

Ø 7,5 cm
Ø 2,9"

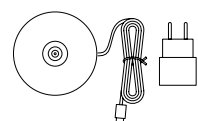

Componenti inclusi

Components included

Base di ricarica a contatto

Contact charging base

Caricabatterie

Charger

Finiture

Finishes



LD1650B3

Bianco / White
RAL 9003

LD1650R3

Corten

LD1650N3

Grigio scuro / Dark grey

LD1650D3

Nero / Black
RAL 9004



LD1650S3

Sabbia / Sand
RAL 1014

LD1650BFO *

Foglia color oro
/ Gold color leaf

LD1650BFA *

Foglia color argento
/ Silver color leaf

LD1650BFO *

Foglia color rame
/ Copper color leaf

* Le lampade con finitura foglia color oro, foglia color argento e foglia color rame non sono adatte per uso esterno.

* The lamps with gold color leaf, silver color leaf and copper color leaf finish are not suitable for outdoor use.

Pina

Supporto da terra

Floor stand



Video Pina



Supporto che trasforma la lampada da tavolo Pina in lampada con picchetto o lampada da terra. L'estremità inferiore del supporto si può montare secondo tre diverse configurazioni: solo con base; solo con picchetto; con picchetto e base, per aumentare la stabilità del supporto. La lampada Pina si alloggia esattamente nella parte superiore del supporto, senza agganciarsi, e può essere agilmente rimossa. Questo supporto non assolve la funzione di ricarica.

A floor stand that turns Pina into a floor lamp or a lamp with peg. The lower end of the stand can be mounted in three different configurations: with the base only, with the peg only, with both peg and base, to increase the stability of the stand. Pina lamp fits exactly in the upper part of the stand, without hooking for easy removal. The floor stand does not charge the lamp.



Pina table lamp sand + Pina floor stand sand
→ LD1650S3 + LD0651S3

Dati tecnici

Technical data

Corpo in alluminio verniciato
Painted aluminum body

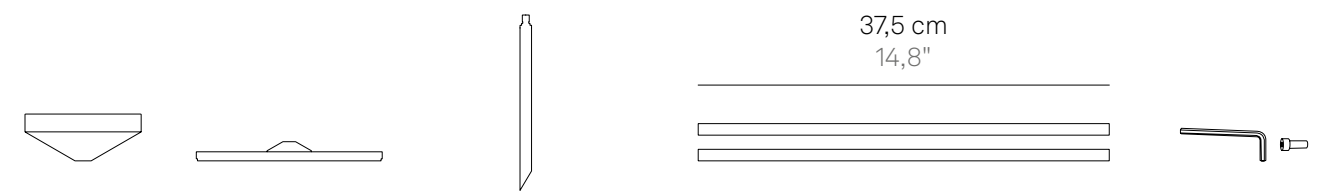
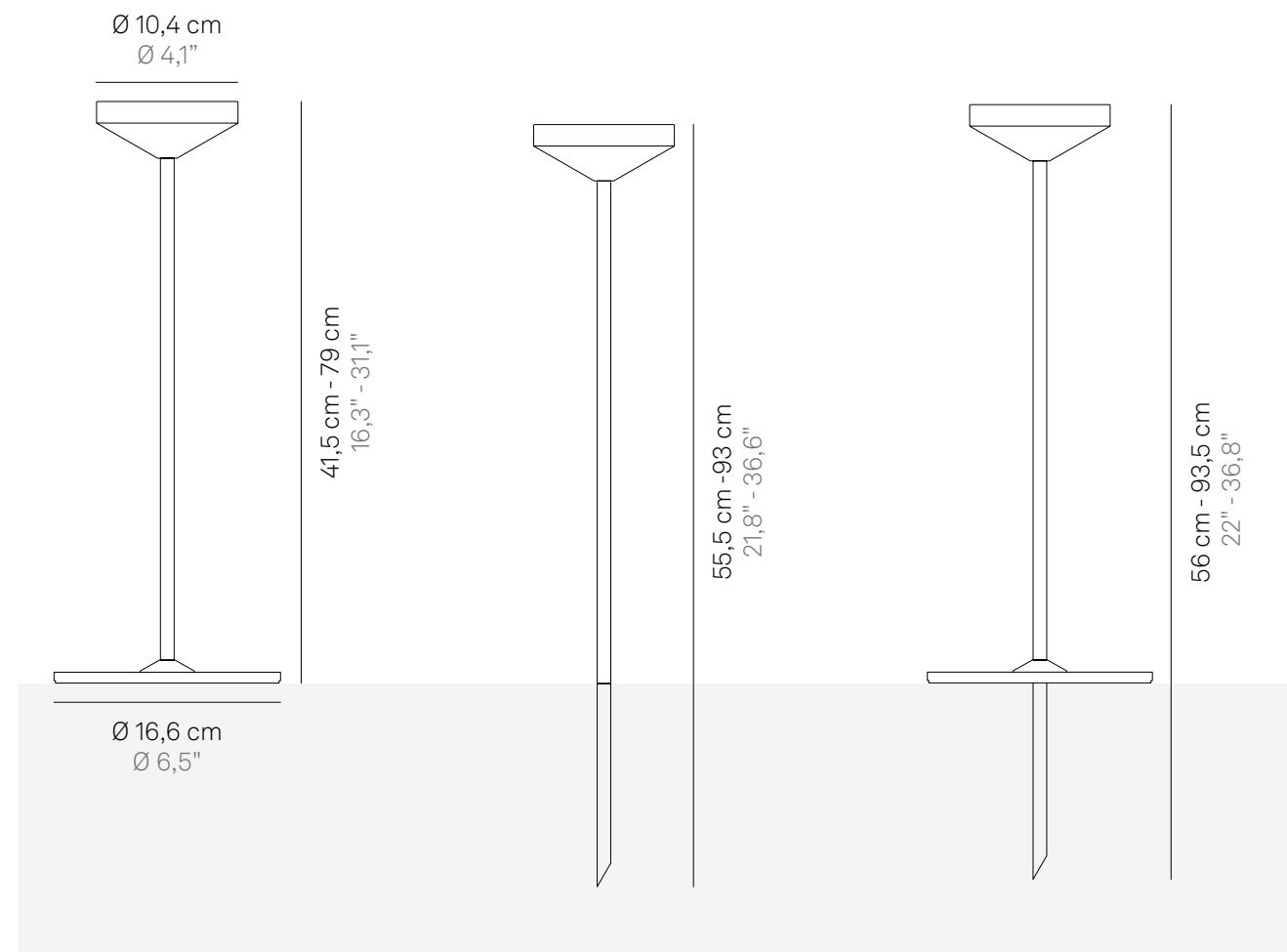

Componenti inclusi
Components included

Base d'appoggio per lampada
Housing for lamp

Base
Base

Picchetto
Peg

Stelo (2 pz.)
Stem (2 pcs.)

Kit di assemblaggio
Assembling kit



Pina table lamp white + Floor stand white
→ **LD1650B3** + **LD0651B3**

Finiture

Finishes



LD0651B3
Bianco
/ White
RAL 9003



LD0651R3
Corten



LD0651N3
Grigio scuro
/ Dark grey



LD0651D3
Nero
/ Black
RAL 9004



LD0651S3
Sabbia
/ Sand



Pina

Vassoio in ceramica made in Italy

Ceramic tray made in Italy

NEW



Dati tecnici

Technical data

CE

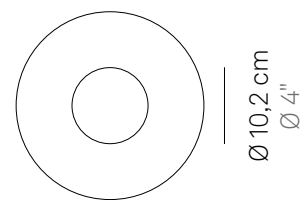

Ø 24,5 cm
Ø 9,6"

Ø 10,2 cm
Ø 4"

Vassoio in ceramica nella cui parte centrale concava, appositamente sagomata, si può alloggiare la lampada da tavolo Pina.

La stretta collaborazione con un'antica fabbrica di Civita Castellana - borgo viterbese dove l'arte della ceramica è attestata fin dal X secolo a.C. - consente a Zafferano di avvalersi di una produzione esclusiva di manufatti "Made in Italy", decorati a mano su disegno proprio.

Ceramic tray with a concave center that houses the base of Pina.

The close partnership with a historic factory in Civita Castellana - a village near Rome, where the art of ceramics has been practiced since the 10th century BC - allows Zafferano to rely on the exclusive production of made in Italy artifacts, which are hand-painted according to Zafferano design.

Finiture

Finishes



LD065201
Bianco - Nero
White - Black



LD065202
Blu notte - blu
Navy blue - blue



LD065203
Sabbia - Azzurro
Sand - Light blue





Pina table lamp corten +
Ceramic tray sand - light blue
→ **LD1650R3 + LD065203**

Swap

Design Studio Kairos and Federico de Majo

Libellula ti muovi
 Quasi invisibile
 Diventi lucciola
 Ci accudisci con una piccola luce
 Vibrante di vetri e di raffinati veli
 Trasformi per noi la tua essenza
 E resti unica dolce compagna.

Dragonfly you move
 Almost invisible
 And become a firefly
 Watching over us with a small light
 Shimmering with glass and refined veils
 You transform your essence for us
 And remain the only sweet companion.

TAVOLO / ACCESSORI / MINI TAVOLO / ACCESSORI
 TABLE LAMP/ ACCESSORIES / MINI TABLE LAMP / ACCESSORIES



Swap table lamp white → **LD1010B3**
 Swap mini table lamp white → **LD1011B3**
 Cansiglio forest
 Treviso, Italy

Swap

Tavolo pro

Table lamp pro



Swap è una lampada da tavolo a batteria, portatile e ricaricabile. Sulla base è presente un controllo "touch", che permette l'accensione e la regolazione dell'intensità luminosa. Grazie a un alto indice di protezione, la lampada è utilizzabile anche all'esterno. Possiede un sistema di controllo elettronico che monitora e segnala l'autonomia residua della batteria, permettendo di ottimizzare le ricariche ed effettuarle sempre in maniera corretta. È dotata di base di ricarica a contatto; caricabatterie incluso. Swap è personalizzabile con paralumi in vetro, ceramica o tessuto, acquistabili separatamente (pag. 114-116-118).

Swap is a rechargeable battery-powered cordless table lamp. A "touch" control on the base allows switching on/off and dimming. It is suitable for both indoor and outdoor use. An electronic control system monitors the remaining autonomy and ensures a constant luminous flux until the battery runs out. Recharging is therefore optimized and always properly done. The lamp comes with a contact charging base; battery charger included. Swap can be customized with glass, ceramic, or fabric lampshades, to be purchased separately (pg. 114-116-118).



Swap table lamp corten
→ LD1010R3



Swap table lamp black + fabric lampshade black
 → **LD1010N3 + LD102005**



Swap table lamp white + glass lampshade
 → **LD1010B3 + LD102004**

Dati tecnici

Technical data

LED TOUCH DIMMER | 100-240V |
2700K | CRI>90 | 50-60Hz | 2W | 267lm |
IP65 | 5Vdc max 1A

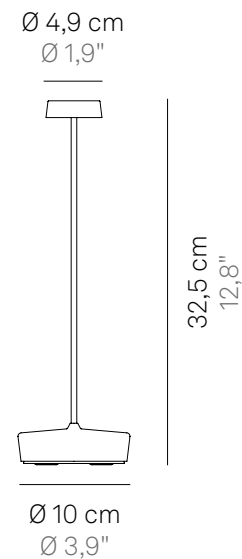

Corpo in pressofusione di alluminio verniciato
Painted die-cast aluminum body

Schermo diffusore in policarbonato
Polycarbonate diffuser

Adatta all'uso esterno (lampada IP65) e interno
(lampada su base di ricarica IP20) → legenda pag. 208
Suitable for outdoor (lamp IP65) and indoor use
(lamp on charging base IP20) → legend pg. 208

Durata di circa 13 h alla massima potenza
Battery lasts about 13 h at full power

Tempo di ricarica a 1A: 6 h
Charging time at 1A: 6 h

Pacco batteria al litio ricaricabile e sostituibile
Rechargeable and replaceable lithium battery pack

Ø 7,5 cm
Ø 2,9"

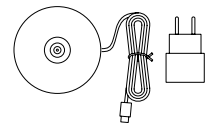
**Componenti inclusi**

Components included

Base di ricarica a contatto
Contact charging base

Caricabatterie
Charger

Finiture

Finishes



LD1010B3
Bianco / White
RAL 9002

LD1010R3
Corten

LD1010N3
Nero / Black
RAL 9005

Swap

Paralume in tessuto

Fabric lampshade



Finiture

Finishes



LD102000
Bianco / White



LD102005
Nero / Black

Dati tecnici

Technical data



Componenti inclusi

Components included

Magnete e dima
Magnet and cut-out

Video tutorial: montaggio paralume
Tutorial video: installation of the lampshade

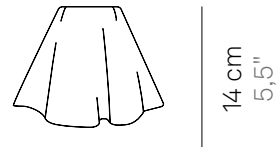

Ø 15 cm
Ø 5,9"

Paralume morbido in tessuto elastico ignifugo, lavabile e ingualcibile, con dischetto in policarbonato e orlo sopraffilato, che si fissa alla testa di Swap tramite un magnete.

A soft lampshade made of fire-retardant elastic fabric, which is washable and crease-resistant, with a polycarbonate disc and a zig-zag edging, that is fixed to the head of the lamp with a magnet.



Swap

Paralume in vetro

Glass lampshade



Dati tecnici

Technical data

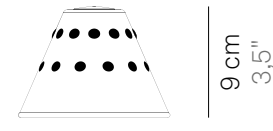

Ø 13 cm
Ø 5,1"

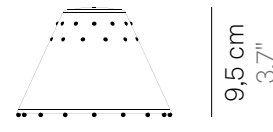

Ø 13 cm
Ø 5,1"

Componenti inclusi

Components included

Magnete e dima
Magnet and cut-out

Video tutorial: montaggio paralume
Tutorial video: installation of the lampshade



Paralume in vetro borosilicato soffiato e lavorato a mano con decorazioni a rilievo, che si fissa alla testa di Swap tramite un magnete.

A handcrafted, blown borosilicate glass lampshade, with relief decorations, that is fixed to the head of the lamp with a magnet.

Finiture

Finishes



LD102001
Bianco / White



LD102002
Nero / Black



LD102003
Ambra / Amber



LD102004
Blu / Blue



LD102011
Bianco / White



LD102012
Nero / Black



LD102013
Ambra / Amber



LD102014
Blu / Blue



Swap

Paralume in ceramica made in Italy

Ceramic lampshade
made in Italy

NEW



Dati tecnici

Technical data

CE

Ø 5,7 cm
Ø 2,2"

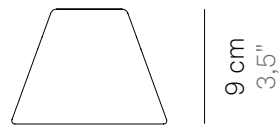

Ø 12,2 cm
Ø 4,8"

9 cm
3,5"

Componenti inclusi
Components included

Magnete e dima
Magnet and cut-out

Video tutorial: montaggio paralume
Tutorial video: installation of the lampshade



Paralume in ceramica che si fissa alla testa di Swap tramite un magnete.

La stretta collaborazione con un'antica fabbrica di Civita Castellana - borgo viterbese dove l'arte della ceramica è attestata fin dal X secolo a.C. - consente a Zafferano di avvalersi di una produzione esclusiva di manufatti "Made in Italy", decorati a mano su disegno proprio o del cliente.

Ceramic lampshade that is fixed to the head of the lamp with a magnet. The close partnership with a historic factory in Civita Castellana - a village near Rome, where the art of ceramics has been practiced since the 10th century BC - allows Zafferano to rely on the exclusive production of made in Italy artifacts, which are hand-painted according to Zafferano design; customization available.

Finiture
Finishes



LD102101
Bianco - Nero
/ White - Black



LD102103
Sabbia - Azzurro
/ Sand - Light blue



Swap mini

Tavolo pro

Table lamp pro



Swap mini è una lampada da tavolo a batteria, portatile e ricaricabile. Sulla base è presente un controllo "touch", che permette l'accensione e la regolazione dell'intensità luminosa. Grazie a un alto indice di protezione, la lampada è utilizzabile anche all'esterno (ad eccezione dei modelli con finitura galvanica, delle quali è sconsigliato l'uso continuativo in esterni). Possiede un sistema di controllo elettronico che monitora e segnala l'autonomia residua della batteria, permettendo di ottimizzare le ricariche ed effettuarle sempre in maniera corretta. È dotata di base di ricarica a contatto; caricabatterie non incluso. È possibile personalizzare la lampada con paralumi in ceramica, acquistabili separatamente

Swap mini is a rechargeable battery-powered cordless table lamp. A "touch" control on the base allows switching on/off and dimming. It is suitable for both indoor and outdoor use (except gold and silver finishes). An electronic control system monitors the remaining autonomy and ensures a constant luminous flux until the battery runs out. Recharging is therefore optimized and always properly done. The lamp comes with a contact charging base; the battery charger is not included. Swap mini can be customized choosing from a range of ceramic lampshades, to be purchased separately



Swap mini table lamp white
→ LD1011B3



Swap mini table lamp
Capri blue → **LD1011K3**



Swap mini table lamp corten
+ ceramic lampshade sand-light blue
→ **LD1011R3 + LD101103**

Dati tecnici

Technical data

LED TOUCH DIMMER | 2700K | CRI>90 |
2W | 267lm | **IP65** | 5 Vdc max 1A



Corpo in pressofusione di alluminio verniciato
Painted die-cast aluminum body

Schermo diffusore in policarbonato
Polycarbonate diffuser

Adatta all'uso esterno (lampada IP65) e interno
(lampada su base di ricarica IP20) → legenda pag. 208
Suitable for outdoor (lamp IP65) and indoor use
(lamp on charging base IP20) → legend pg. 208

Durata di circa 13 h alla massima potenza
Battery lasts about 13 h at full power

Tempo di ricarica a 1A: 6 h
Charging time at 1A: 6 h

Pacco batteria al litio ricaricabile e sostituibile
Rechargeable and replaceable lithium battery pack

Avvertenze

Remarks

Le lampade con finitura galvanica lucida oro e cromo
non sono adatte per uso esterno.

The lamps with gold and chrome glossy galvanic finish
are not suitable for outdoor use.

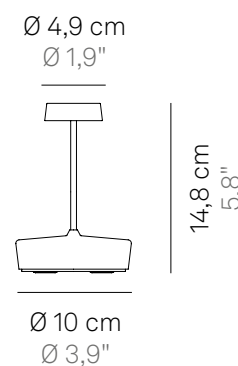

Ø 7,5 cm
Ø 2,9"

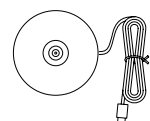
**Componenti inclusi**

Components included

Base di ricarica a contatto
Contact charging base

Accessori non inclusi

Accessories not included

Caricabatterie → pag. 199
Charger → pg. 199

Finiture

Finishes



LD1011B3
Bianco / White
RAL 9002



LD1011R3
Corten



LD1011N3
Nero / Black
RAL 9005



LD1011O3 *
Oro lucido
/ Glossy gold



LD1011C3 *
Cromo lucido
/ Glossy chrome



LD1011K3
Blu Capri
/ Capri blue
RAL 5019



LD1011L3
Lilla / Lilac
RAL 4005



LD1011V3
Verde mela
/ Apple green
RAL 6018



LD1011Z3
Arancio / Orange
RAL 2008

* Le lampade con finitura galvanica lucida oro e cromo non sono adatte per uso esterno.
* The lamps with gold and chrome glossy galvanic finish are not suitable for outdoor use.

Swap mini

Paralume in ceramica made in Italy

Ceramic lampshade
made in Italy



NEW

Dati tecnici

Technical data

CE

Ø 5,7 cm
Ø 2,2"

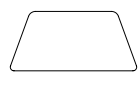

4 cm
1,6"

Ø 8,5 cm
Ø 3,3"

Componenti inclusi Components included

Magnete e dima
Magnet and cut-out

Video tutorial: montaggio paralume
Tutorial video: installation of the lampshade



Paralume in ceramica che si fissa alla testa di Swap mini tramite un magnete. La stretta collaborazione con un'antica fabbrica di Civita Castellana - borgo viterbese dove l'arte della ceramica è attestata fin dal X secolo a.C. - consente a Zafferano di avvalersi di una produzione esclusiva di manufatti "Made in Italy", decorati a mano su disegno proprio o del cliente.

Ceramic lampshade that is fixed to the head of the lamp with a magnet. The close partnership with a historic factory in Civita Castellana - a village near Rome, where the art of ceramics has been practiced since the 10th century BC - allows Zafferano to rely on the exclusive production of made in Italy artifacts, which are hand-painted according to Zafferano design; customization available.

Finiture Finishes



LD101101
Bianco - Nero
/ White - Black



LD101102
Blu notte - Blu
/ Navy blue - Blue



LD101103
Sabbia - Azzurro
/ Sand - Light blue



LD101104
Pesci azzurri
/ Light blue fish



LD101105
Pois verdi
/ Green dots



LD101106
Pois arancio
/ Orange dots



LD101107
Pois azzurri
/ Light blue dots



LD101108
Pois rosso
/ Red dots



LD101109
Pois neri
/ Black dots

Push-up

Cuore di luce
Animo forte
Ti apri come madreperla
Donando un immediato piacere
Una inaspettata luminosità.

Heart of light
Powerful spirit
You open like a mother-of-pearl shell
Giving instant pleasure,
Unexpected luminosity.

TAVOLO
TABLE LAMP



Push-up table lamp corten → **LD1050R3**
Padua, Italy

Push-up

Tavolo pro Table lamp pro

NEW



Video Push-up



Push-up è una lampada da tavolo a batteria, portatile e ricaricabile. Premendo la parte superiore della lampada, questa si solleva e contemporaneamente si accende; premendo nuovamente fino alla chiusura, la lampada si spegne. Sotto la base è presente un controllo "touch", che – quando la parte superiore della lampada è sollevata – permette lo spegnimento, la regolazione dell'intensità luminosa e la selezione della temperatura di colore della luce tra 2200K, 2700K e 3000K. Grazie a un alto indice di protezione, la lampada è utilizzabile anche all'esterno. Possiede un sistema di controllo elettronico che monitora e segnala l'autonomia residua della batteria, permettendo di ottimizzare le ricariche ed effettuarle sempre in maniera corretta. È dotata di base di ricarica a contatto; caricabatterie non incluso.

Push-up is a rechargeable battery-powered cordless table lamp. Pushing the lid down, lifts the diffuser up and turns the light on; pushing the lid back down, closes the lamp while turning the light off. A "touch" control hidden under the base allows switching on/off, dimming, and selecting the color temperature of the light (2200K, 2700K or 3000K). It is suitable for both indoor and outdoor use. An electronic control system monitors the remaining autonomy and ensures a constant luminous flux until the battery runs out. Recharging is therefore optimized and always properly done. The lamp comes with a contact charging base; the battery charger is not included.

Push-up table lamp
white → LD1050B3



Dati tecnici

Technical data

LED TOUCH DIMMER | 2200-2700-
3000K | CRI>80 | 2,2W | 207-235-248lm |
IP54 | 5 Vdc max 1A



Corpo in pressofusione di alluminio verniciato
Painted die-cast aluminum body

Schermo diffusore in policarbonato
Polycarbonate diffuser

Adatta all'uso esterno (lampada IP54) e interno
(lampada su base di ricarica IP20) → legenda pag. 208
Suitable for outdoor (lamp IP54) and indoor use
(lamp on charging base IP20) → legend pg. 208

Durata di circa 11/12 h alla massima potenza
Battery lasts about 11/12 h at full power

Tempo di ricarica a 1A: 5/6 h
Charging time at 1A: 5/6 h

Pacco batteria al litio ricaricabile e sostituibile
Rechargeable and replaceable lithium battery pack

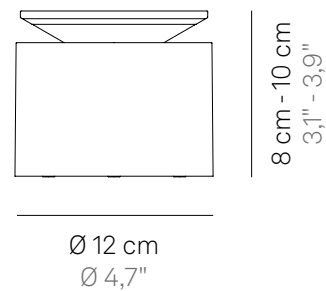

Ø 10 cm
Ø 3,9"

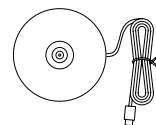
**Componenti inclusi**

Components included

Base di ricarica a contatto
Contact charging base

Accessori non inclusi

Accessories not included

Caricabatterie → pag. 199
Charger → pg. 199

Finiture

Finishes



LD1050B3
Bianco / White
RAL 9003



LD1050R3
Corten



LD1050N3
Grigio scuro / Dark grey



LD1050S3
Sabbia / Sand



Push-up table lamp dark grey → **LD1050N3**
Push-up table lamp corten → **LD1050R3**

Home

Voglio una casa illuminata
 Tanto grande e tanto piccola
 Come la penso ogni giorno
 Con tanti o pochi amici
 Vere presenze
 Penso la casa sul mare e sulla sabbia
 Sul prato ombreggiato dal tiglio
 E sulla montagna dopo il tramonto
 Che racconta dei nostri tanti passi.

I'd like a bright house
 As large and as small
 As I imagine it every day
 With many or a few friends
 True presences
 I imagine a house by the sea and on the sand
 On the lawn, in the shade of a linden tree
 And in the mountains after sunset
 That reveals our many steps.

TAVOLO / SUPPORTO PARETE
 TABLE LAMP / WALL LAMP KIT



Home table lamp white → **LD0258B3**
 Home table lamp dark grey → **LD0258N3**

Euganean hills
 Padua, Italy

Home

Tavolo pro Table lamp pro



Home è una lampada da tavolo a batteria, portatile e ricaricabile. Sulla base è presente un controllo "touch", che permette l'accensione e la regolazione dell'intensità luminosa. Grazie a un alto indice di protezione, la lampada è utilizzabile anche all'esterno. Possiede un sistema di controllo elettronico che monitora e segnala l'autonomia residua della batteria, permettendo di ottimizzare le ricariche ed effettuarle sempre in maniera corretta. È dotata di base di ricarica a contatto; caricabatterie incluso. Home può diventare una lampada da parete tramite l'apposito accessorio, acquistabile separatamente (pag. 140).

Home is a rechargeable battery-powered cordless table lamp. A "touch" control on the base allows switching on/off and dimming. It is suitable for both indoor and outdoor use. An electronic control system monitors the remaining autonomy and ensures a constant luminous flux until the battery runs out. Recharging is therefore optimized and always properly done. The lamp comes with a contact charging base; the battery charger is included. Home can become a wall lamp thanks its dedicated accessory, to be purchased separately (pg. 140).

Home table lamp white
→ LD0258B3



Dati tecnici

Technical data

LED TOUCH DIMMER | 100-240V |
3000K | CRI>80 | 50-60Hz | 2,2W |
260lm | **IP54** | 5Vdc max 1A



Corpo in pressofusione di alluminio verniciato
Painted die-cast aluminum body

Schermo diffusore in policarbonato
Polycarbonate diffuser

Adatta all'uso esterno (lampada IP54) e interno
(lampada su base di ricarica IP20) → legenda pag. 208
Suitable for outdoor (lamp IP54) and indoor use
(lamp on charging base IP20) → legend pg. 208

Durata di circa 12 h alla massima potenza
Battery lasts about 12 h at full power

Tempo di ricarica a 1A: 6/8 h
Charging time at 1A: 6/8 h

Pacco batteria al litio ricaricabile e sostituibile
Rechargeable and replaceable lithium battery pack



10 x 10 cm
3,9" x 3,9"

Ø 7,5 cm
Ø 2,9"

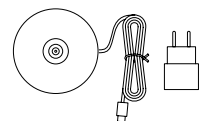
**Componenti inclusi**

Components included

Base di ricarica a contatto
Contact charging base

Caricabatterie
Charger

Finiture

Finishes



LD0258B3
Bianco / White
RAL 9003



LD0258R3
Corten



LD0258N3
Grigio scuro / Dark grey

Home

Supporto parete Wall lamp kit

NEW



Dati tecnici Technical data

CE

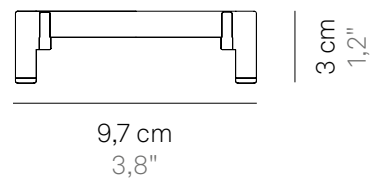

Finiture Finishes



LD0259B3
Bianco
/ White
RAL 9003

LD0259R3
Corten

LD0259N3
Grigio scuro
/ Dark grey

Supporto in pressofusione d'alluminio verniciato
Painted die-cast aluminum element



Supporto che trasforma la lampada da tavolo Home in lampada da parete. La lampada può essere usata nel suo supporto fisso, ma anche rimossa e portata con sé da un ambiente all'altro.

A wall bracket that turns Home into a wall lamp. The lamp can be used in its fixed housing or detached and carried from one place to another.

Home table lamp white
+ Home wall lamp kit white
→ **LD0258B3** + **LD0259B3**

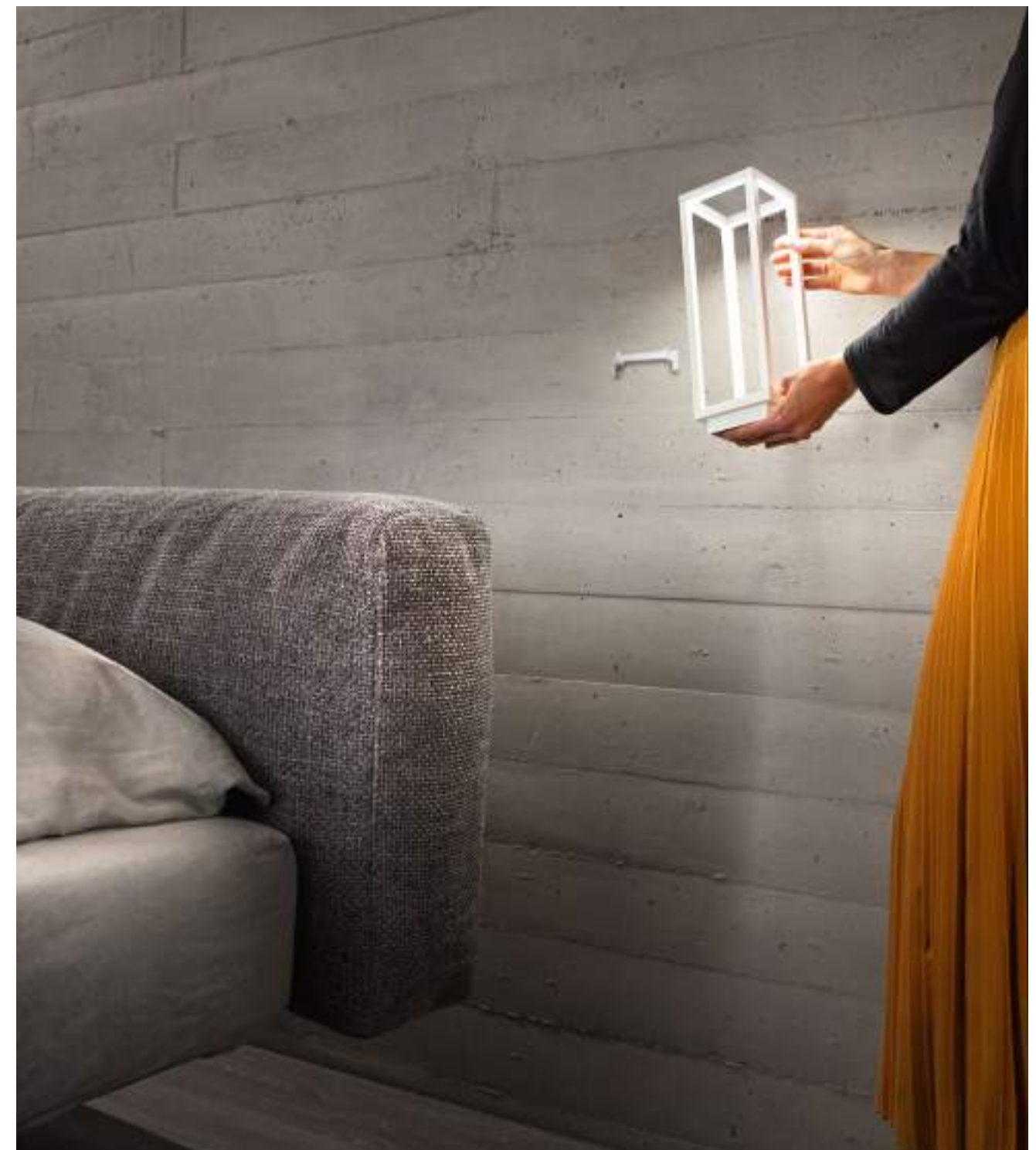

Dama

A stone shines
light awakens it
while a small moon
radiates a faint yet vibrant glow.
The endless passage of much water
has patiently smoothed it.

Un sasso risplende
la luce lo risveglia
mentre una piccola luna
emana un chiarore flebile ma vivo.
È il passaggio perpetuo di tanta acqua
che paziente lo ha levigato.

TAVOLO
TABLE LAMP



Dama table lamp white
→ **LD0610B3**
Piave riverbed
Treviso, Italy

Dama

Tavolo pro Table lamp pro



Dama è una lampada da tavolo a batteria, portatile e ricaricabile. Nella parte superiore della testa è presente un controllo "touch", che permette l'accensione, la regolazione dell'intensità luminosa e la selezione della temperatura di colore della luce tra 2200K, 2700K e 3000K. Grazie a un alto indice di protezione, la lampada è utilizzabile anche all'esterno. Possiede un sistema di controllo elettronico che monitora e segnala l'autonomia residua della batteria, permettendo di ottimizzare le ricariche ed effettuarle sempre in maniera corretta. È dotata di base di ricarica a contatto; caricabatterie incluso.

Dama is a rechargeable battery-powered cordless table lamp. A "touch" control on the head allows switching on/off, dimming, and selecting the color temperature of the light (2200K, 2700K or 3000K). It is suitable for both indoor and outdoor use. An electronic control system monitors the remaining autonomy and ensures a constant luminous flux until the battery runs out. Recharging is therefore optimized and always properly done. The lamp comes with a contact charging base; the battery charger is included.

Dama table lamp white
→ **LD0610B3**



Dati tecnici

Technical data

LED TOUCH DIMMER | 100-240V | 2200-2700-3000K | CRI>80 | 50-60Hz | 2,2W | 194-219-221lm | **IP54** | 5Vdc max 1A

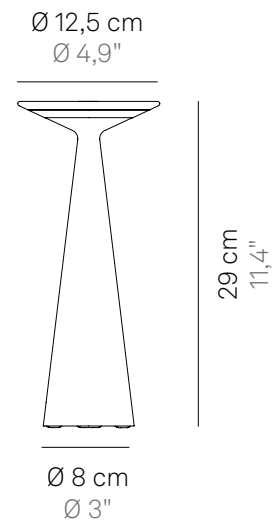

Ø 7,5 cm
Ø 2,9"

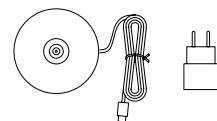

Corpo in pressofusione di alluminio verniciato
Painted die-cast aluminum body

Schermo diffusore in policarbonato
Polycarbonate diffuser

Adatta all'uso esterno (lampada IP54) e interno (lampada su base di ricarica IP20) → legenda pag. 208
Suitable for outdoor (lamp IP54) and indoor use (lamp on charging base IP20) → legend pg. 208

Durata di circa 9 h alla massima potenza
Battery lasts about 9 h at full power

Tempo di ricarica a 1A: 6 h
Charging time at 1A: 6 h

Pacco batteria al litio ricaricabile e sostituibile
Rechargeable and replaceable lithium battery pack

Finiture

Finishes



LD0610B3
Bianco / White
RAL 9003

LD0610N3
Nero opaco / Black
RAL 9004



Dama table lamp white
→ **LD0610B3**
Ristorante Le Lampare
al Fortino - Trani, Italy
Photo Vito Rizzi Photographer

Componenti inclusi

Components included

Base di ricarica a contatto
Contact charging base

Caricabatterie
Charger

Olimpia

Design Federico de Majo

Luna luminosa, piena
la tua luce
penetra nei solchi, negli anfratti.
Gradino dopo gradino
ci avviciniamo.

Bright full moon
your light
penetrates furrows and crevices.
Step by step
we draw near.

TAVOLO
TABLE LAMP



Olimpia table lamp
white → **LD0900B3**
Brent de l'Art
Belluno, Italy

Olimpia

Tavolo pro Table lamp pro



Olimpia è una lampada da tavolo a batteria, portatile e ricaricabile. Sulla base è presente un controllo "touch", che permette l'accensione e la regolazione dell'intensità luminosa. Grazie a un alto indice di protezione, la lampada è utilizzabile anche all'esterno (ad eccezione dei modelli con finitura galvanica, delle quali è sconsigliato l'uso continuativo in esterni). È possibile rendere più caldo il colore della luce, sostituendo il filtro già presente sulla sorgente luminosa con quello color ambra (fornito in dotazione). È dotata di base di ricarica a contatto; caricabatterie incluso.

Olimpia is a rechargeable battery-powered cordless table lamp. A "touch" control on the base allows switching on/off and dimming. It is suitable for both indoor and outdoor use (except gold and silver finishes). The color temperature of the light can be changed to warmer by swapping the filter onboard with the amber one (included). The lamp comes with a contact charging base; the battery charger is included.

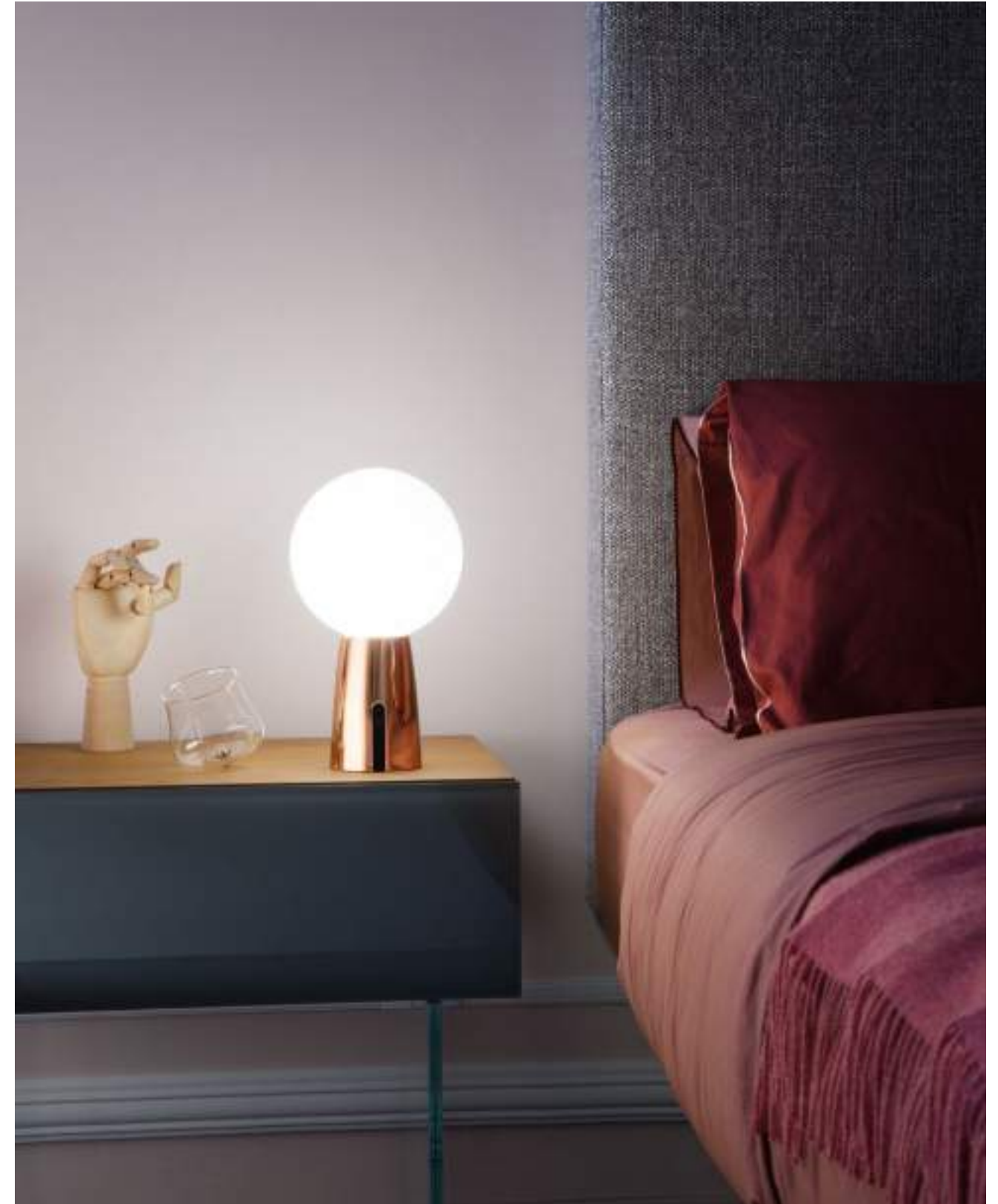

Olimpia table lamp copper
→ LD0900E3

Dati tecnici

Technical data

LED TOUCH DIMMER | 100-240V |
3000K | CRI>80 | 50-60Hz | 2,5W |
268lm | **IP54** | 5Vdc max 1A



Corpo in pressofusione di alluminio verniciato
Painted die-cast aluminum body

Schermo diffusore in policarbonato
Polycarbonate diffuser

Adatta all'uso esterno (lampada IP54) e interno
(lampada su base di ricarica IP20) → legenda pag. 208
Suitable for outdoor (lamp IP54) and indoor use
(lamp on charging base IP20) → legend pg. 208

Durata di circa 9 h alla massima potenza
Battery lasts about 9 h at full power

Tempo di ricarica a 1A: 9 h
Charging time at 1A: 9 h

Pacco batteria al litio ricaricabile e sostituibile
Rechargeable and replaceable lithium battery pack

Avvertenze

Remarks

Le lampade con finitura oro, cromo e rame
non sono adatte per uso esterno.
The lamps with gold, chrome and silver finish
are not suitable for outdoor use.

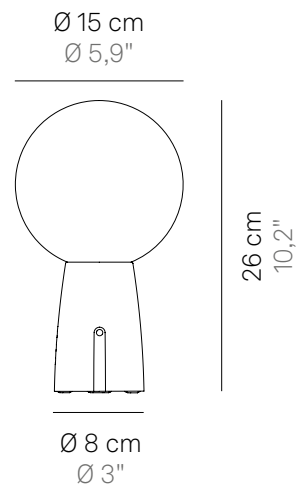

Ø 7,5 cm
Ø 2,9"

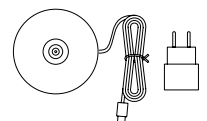

Ø 3,3 cm
Ø 1,3"

Componenti inclusi

Components included

Base di ricarica a contatto
Contact charging base

Caricabatterie
Charger

Filtro
Lens

Finiture

Finishes



LD0900B3
Bianco / White
RAL 9003



LD0900N3
Grigio scuro / Dark grey



LD0900O3 *
Oro lucido / Glossy gold



LD0900C3 *
Cromo lucido / Glossy
chrome



LD0900E3 *
Rame lucido
/Glossy copper

* Le lampade con finitura color oro, cromo e rame non sono adatte per uso esterno.
* The lamps with gold, chromo and copper finish are not suitable for outdoor use.

Sister Light

Design Federico de Majo

An enchanted forest
rich in greenery
and glowing mushrooms.
Eyes of elves, hidden
spy on your many powers.

Un bosco incantato
ricco di vegetazione
e funghi fosforescenti.
Occhi di elfi, nascosti
spiano le tue molteplici abilità.

TAVOLO / MINI TAVOLO / PICCHETTO / PARETE
TABLE LAMP / MINI TABLE LAMP / LAMP WITH PEG / WALL LAMP



Sister Light table lamp gold → **LD030003**
Sister Light mini table lamp gold → **LD030603**
Rosoline pine forest
Rovigo, Italy



Sister Light table lamp
copper → **LD0300R3**
42 Restaurant & Bar
Esztergom, Hungary
Photo Patrik Fábian



Sister Light

Tavolo Table lamp



Sister Light è una lampada da tavolo a batteria, portatile e ricaricabile. Nella parte superiore della testa è presente un controllo "touch" che permette l'accensione, la regolazione dell'intensità luminosa (dimmerazione a 4 step) e la selezione della temperatura di colore della luce tra 2700K, 3150K e 4000K. Grazie a un alto indice di protezione, la lampada è utilizzabile anche all'esterno; resiste inoltre alla nebbia salina (1500 h). La testa della lampada, avvitata sullo stelo, è convertibile a fissaggio magnetico e dunque può essere separata per diventare una fonte luminosa di emergenza. La base della lampada è predisposta per il fissaggio meccanico al tavolo. Possiede un sistema di controllo elettronico che monitora l'autonomia residua e garantisce un flusso luminoso costante fino all'esaurimento della batteria, permettendo di ottimizzare le ricariche ed effettuarle sempre in maniera corretta. È dotata di cavo USB Type-C per la ricarica; caricabatterie non incluso.

Sister Light is a rechargeable battery-powered cordless table lamp. A "touch" control on the head allows switching on, dimming (4-step: 100%, 60%, 30%, 6%) and selecting the color temperature of the light (2700K, 3150K or 4000K). It is suitable for both indoor and outdoor use and salt spray resistant (1500 h). The head of the lamp comes screwed to the stem; it can be converted to magnetic fixing and detached to become an emergency light. The base of the lamp is designed to be mechanically fixed to a table. An electronic control system monitors the remaining autonomy and ensures a constant luminous flux until the battery runs out. Recharging is therefore optimized and always properly done. The lamp comes with a USB Type-C cable for recharging; the battery charger is not included.



Sister Light table lamp blue
→ **LD0300B3**

Dati tecnici

Technical data

LED TOUCH DIMMER | 2700-3150-4000K | CRI>90 | 3W | 305-326-328lm |
IP65 | 5 Vdc max 2A

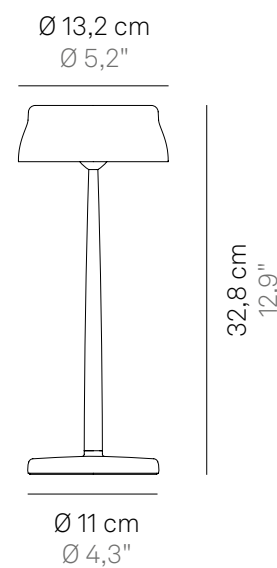

Corpo in alluminio anodizzato spazzolato
 Brushed anodized aluminum body

Diffusore in policarbonato prismatico
 Prismatic polycarbonate diffuser

Adatta all'uso esterno (lampada IP65) e interno (lampada su base di ricarica IP20) → legenda pag. 208
 Suitable for outdoor (lamp IP65) and indoor use (lamp on charging base IP20) → legend pg. 208

Resistenza agli urti (IK07) e alla nebbia salina (1500h)
 Impact resistance (IK07) and salt spray resistance (1500h)

Durata 8 - 58 h, in base alla regolazione del flusso luminoso
 Battery lasts 8 - 58 h, depending on the luminous flux setting.

Tempo di ricarica a 2A: circa 5 h
 Charging time at 2A: about 5 h

Ricarica con cavetto USB-c
 Rechargeable with a USB-c cable

Pacco batteria al litio ricaricabile e sostituibile
 Rechargeable and replaceable lithium battery pack

Finiture

Finishes



LD030003
 Oro / Gold



LD0300A3
 Alluminio / Aluminum



LD0300R3
 Rame / Copper



LD0300V3
 Verde / Green



LD0300B3
 Blu / Blue

Componenti inclusi

Components included

Cavo di ricarica con entrata USB-c
 Charging cable with USB-c input

Kit per fissaggio magnetico
 Kit for magnetic fixing

Kit per fissaggio meccanico al tavolo
 Kit for mechanical fixing to a table

Componente non incluso

Component not included

Caricabatterie 5Vdc max 2,1A * → pag. 199
 Charger 5Vdc max 2,1A * → pg. 199

* Componente necessario, da acquistare separatamente

* Necessary component, yet it must be purchased separately

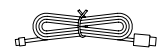

Sister Light mini

Tavolo

Table lamp



Sister Light mini è una lampada da tavolo a batteria, portatile e ricaricabile. Nella parte superiore della testa è presente un controllo “touch” che permette l'accensione, la regolazione dell'intensità luminosa (dimmerazione a 4 step) e la selezione della temperatura di colore della luce tra 2700K, 3150K e 4000K. Grazie a un alto indice di protezione, la lampada è utilizzabile anche all'esterno; resiste inoltre alla nebbia salina (1500 h). La testa della lampada, avvitata sullo stelo, è convertibile a fissaggio magnetico e dunque può essere separata per diventare una fonte luminosa di emergenza. La base della lampada è predisposta per il fissaggio meccanico al tavolo. Possiede un sistema di controllo elettronico che monitora l'autonomia residua e garantisce un flusso luminoso costante fino all'esaurimento della batteria, permettendo di ottimizzare le ricariche ed effettuarle sempre in maniera corretta. È dotata di cavo USB Type-C per la ricarica; caricabatterie non incluso.

Sister Light mini is a rechargeable battery-powered cordless table lamp. A "touch" control on the head allows switching on/off, dimming (4-step: 100%, 60%, 30%, 6%) and selecting the color temperature of the light (2700K, 3150K or 4000K). It is suitable for both indoor and outdoor use and salt spray resistant (1500 h). The head of the lamp comes screwed to the stem; it can be converted to magnetic fixing and detached to become an emergency light. The base of the lamp is designed to be mechanically fixed to a table. An electronic control system monitors the remaining autonomy and ensures a constant luminous flux until the battery runs out. Recharging is therefore optimized and always properly done. The lamp comes with a USB Type-C cable per recharging; the battery charger is not included.

Sister Light mini table lamp
gold → LD030603



Dati tecnici

Technical data

LED TOUCH DIMMER | 2700-3150-4000K | CRI>90 | 3W | 305-326-328lm | IP65 | 5 Vdc max 2A



Corpo in alluminio anodizzato spazzolato
Brushed anodized aluminum body

Diffusore in policarbonato prismatico
Prismatic polycarbonate diffuser

Adatta all'uso esterno (lampada IP65) e interno (lampada su base di ricarica IP20) → legenda pag. 208
Suitable for outdoor (lamp IP65) and indoor use (lamp on charging base IP20) → legend pg. 208

Resistenza agli urti (IK07) e alla nebbia salina (1500h)
Impact resistance (IK07) and salt spray resistance (1500h)

Durata 8 - 58 h, in base alla regolazione del flusso luminoso
Battery lasts 8 - 58 h, depending on the luminous flux setting.

Tempo di ricarica a 2A: circa 5 h
Charging time at 2A: about 5 h

Ricarica con cavetto USB-c
Rechargeable with a USB-c cable

Pacco batteria al litio ricaricabile e sostituibile
Rechargeable and replaceable lithium battery pack

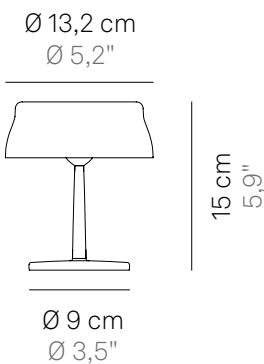
**Componenti inclusi**

Components included

Cavo di ricarica con entrata USB-c
Charging cable with USB-c input

Kit per fissaggio magnetico
Kit for magnetic fixing

Kit per fissaggio meccanico al tavolo
Kit for mechanical fixing to a table

Componente non incluso

Component not included

Caricabatterie 5Vdc max 2,1A * → pag. 199
Charger 5Vdc max 2,1A * → pg. 199

* Componente necessario, da acquistare separatamente
* Necessary component, yet it must be purchased separately

Finiture

Finishes



LD030603
Oro / Gold



LD0306R3
Rame / Copper



LD0306V3
Verde / Green



Sister Light mini table lamp gold → **LD030603**
Hotel Venice Venice
Venezia, Italy

Sister Light

Picchetto

Lamp with peg



Sister Light è una lampada a batteria, portatile e ricaricabile con picchetto. Nella parte superiore della testa è presente un controllo “touch” che permette l’accensione, la regolazione dell’intensità luminosa (dimmerazione a 4 step) e la selezione della temperatura di colore della luce tra 2700K, 3150K e 4000K. Grazie a un alto indice di protezione, la lampada è utilizzabile anche all’esterno; resiste inoltre alla nebbia salina (1500 h). La testa della lampada, calamitata sullo stelo (convertibile a fissaggio meccanico) può essere separata per diventare una fonte luminosa di emergenza. La lampada è fornita con un kit di elementi che permette di configurarne l’altezza in tre misure: 56, 81 o 106 cm. Possiede un sistema di controllo elettronico che monitora l’autonomia residua e garantisce un flusso luminoso costante fino all’esaurimento della batteria, permettendo di ottimizzare le ricariche ed effettuarle sempre in maniera corretta. È dotata di cavo USB Type-C per la ricarica; caricabatterie non incluso.

Sister Light is a rechargeable battery-powered cordless lamp with peg. A "touch" control on the head allows switching on/off, dimming (4-step: 100%, 60%, 30%, 6%) and selecting the color temperature of the light (2700K, 3150K or 4000K). It is suitable for both indoor and outdoor use and salt spray resistant (1500 h). The head of the lamp comes screwed to the stem; it can be converted to magnetic fixing and detached to become an emergency light. It is provided with a 3-rod kit that allows to choose the height of the lamp among 56, 81 or 106 cm. An electronic control system monitors the remaining autonomy and ensures a constant luminous flux until the battery runs out. Recharging is therefore optimized and always properly done. The lamp comes with a USB Type-C cable per recharging; the battery charger is not included.

Sister Light lamp with peg green → **LD0302V3**
Sister Light lamp with peg copper → **LD0302R3**



Dati tecnici

Technical data

LED TOUCH DIMMER | 2700-3150-4000K | CRI>90 | 3W | 305-326-328lm |
IP65 | 5 Vdc max 2A

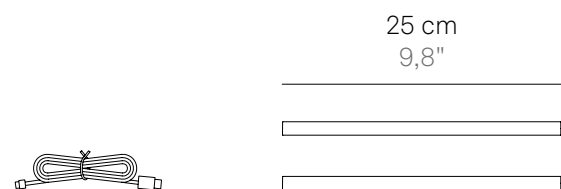
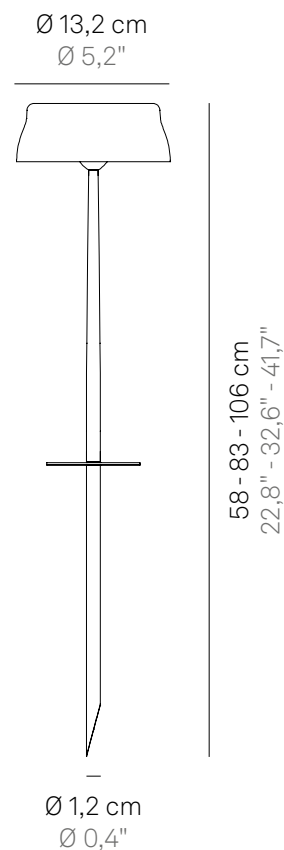

Corpo in alluminio anodizzato spazzolato
 Brushed anodized aluminum body

Diffusore in policarbonato prismatico
 Prismatic polycarbonate diffuser

Adatta all'uso esterno (lampada IP65) e interno (lampada su base di ricarica IP20) → legenda pag. 208
 Suitable for outdoor (lamp IP65) and indoor use (lamp on charging base IP20) → legend pg. 208

Resistenza agli urti (IK07) e alla nebbia salina (1500h)
 Impact resistance (IK07) and salt spray resistance (1500h)

Durata 8 - 58 h, in base alla regolazione del flusso luminoso
 Battery lasts 8 - 58 h, depending on the luminous flux setting.

Tempo di ricarica a 2A: circa 5 h
 Charging time at 2A: about 5 h

Ricarica con cavetto USB-c
 Rechargeable with a USB-c cable

Pacco batteria al litio ricaricabile e sostituibile
 Rechargeable and replaceable lithium battery pack

Avvertenze

Remarks

La testa della lampada può essere svitata per avvicinarla a una fonte di alimentazione, facilitando l'operazione di ricarica.

The head can be removed from the body of the lamp for easier recharging.

Componenti inclusi

Components included

Cavo di ricarica con entrata USB-c
 Charging cable with USB-c input

Kit per fissaggio magnetico
 Kit for magnetic fixin

Stelo (2 pz.)
 Stem (2 pcs.)

Componente non incluso

Component not included

Caricabatterie 5Vdc max 2,1A * → pag. 199
 Charger 5Vdc max 2,1A * → pg. 199

* Componente necessario, da acquistare separatamente

* Necessary component, yet it must be purchased separately

Finiture

Finishes



LD0302R3
 Rame / Copper

LD0302V3
 Verde / Green

Sister Light

Parete Wall lamp



Sister Light wall lamp
copper → **LD0308R3**

Sister Light parete è una lampada a batteria, portatile e ricaricabile. Nella parte superiore della testa è presente un controllo "touch" che permette l'accensione, la regolazione dell'intensità luminosa (dimmerazione a 4 step) e la selezione della temperatura di colore della luce tra 2700K, 3150K e 4000K. Grazie a un alto indice di protezione, la lampada è utilizzabile anche all'esterno; resiste inoltre alla nebbia salina (1500 h). La testa della lampada, calamitata sul braccio (convertibile a fissaggio meccanico) può essere separata per diventare una fonte luminosa di emergenza. Possiede un sistema di controllo elettronico che monitora l'autonomia residua e garantisce un flusso luminoso costante fino all'esaurimento della batteria, permettendo di ottimizzare le ricariche ed effettuarle sempre in maniera corretta. È dotata di cavo USB Type-C per la ricarica; caricabatterie non incluso.

Sister Light is a rechargeable battery-powered cordless wall lamp. A "touch" control on the head allows switching on/off, dimming (4-step: 100%, 60%, 30%, 6%) and selecting the color temperature of the light (2700K, 3150K or 4000K). It is suitable for both indoor and outdoor use and salt spray resistant (1500 h). The head of the lamp is magnetically attached to the arm; it can be detached to become an emergency light. The fixing kit can be converted from magnetic to mechanical. An electronic control system monitors the remaining autonomy and ensures a constant luminous flux until the battery runs out. Recharging is therefore optimized and always properly done. The lamp comes with a USB Type-C cable per recharging; the battery charger is not included.



Dati tecnici

Technical data

LED TOUCH DIMMER | 2700-3150-4000K | CRI>90 | 3W | 305-326-328lm | **IP65** | 5 Vdc max 2A

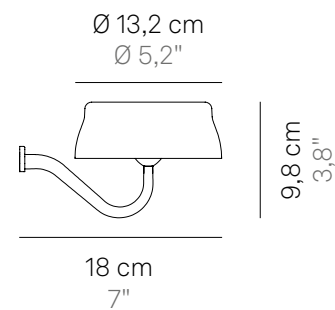

Corpo in alluminio anodizzato spazzolato
Brushed anodized aluminum body

Diffusore in policarbonato prismatico
Prismatic polycarbonate diffuser

Adatta all'uso esterno (lampada IP65) e interno (lampada su base di ricarica IP20) → legenda pag. 208
Suitable for outdoor (lamp IP65) and indoor use (lamp on charging base IP20) → legend pg. 208

Resistenza agli urti (IK07) e alla nebbia salina (1500h)
Impact resistance (IK07) and salt spray resistance (1500h)

Durata 8 - 58 h, in base alla regolazione del flusso luminoso
Battery lasts 8 - 58 h, depending on the luminous flux setting.

Tempo di ricarica a 2A: circa 5 h
Charging time at 2A: about 5 h

Ricarica con cavetto USB-c
Rechargeable with a USB-c cable

Pacco batteria al litio ricaricabile e sostituibile
Rechargeable and replaceable lithium battery pack

Avvertenze

Remarks

La testa della lampada può essere svitata per avvicinarla a una fonte di alimentazione, facilitando l'operazione di ricarica.

The head can be removed from the body of the lamp for easier recharging.

**Componenti inclusi**

Components included

Cavo di ricarica con entrata USB-c
Charging cable with USB-c input

Kit per fissaggio magnetico
Kit for magnetic fixing

Componente non incluso

Component not included

Caricabatterie 5Vdc max 2,1A * → pag. 199
Charger 5Vdc max 2,1A * → pg. 199

* Componente necessario, da acquistare separatamente

* Necessary component, yet it must be purchased separately

Finiture

Finishes

**LD0308R3**

Rame / Copper

LD0308V3

Verde / Green



Sister Light wall lamp
green → **LD0308V3**

Pencil

Design Federico de Majo

Sospesa magicamente
abbracciata o libera
sembri sostenere il peso del tronco.
Esile presenza
ti presti a giocare
in una luminosa danza.

Magically suspended
embraced or free
you appear to be bearing the weight of a trunk.
Slender presence
you play along
in a luminous dance.

MODULO LUCE / CARICABATTERIE / BASE DI STAZIONAMENTO E RICARICA / BASE DI STAZIONAMENTO ROTANTE / SUPPORTI TAVOLO /
SUPPORTI PARETE ORIZZONTALE / SUPPORTO PARETE VERTICALE / SUPPORTO SOSPENSIONE VERTICALE / SUPPORTI SOSPENSIONE
ORIZZONTALE LIGHTING MODULE / BATTERY CHARGER / DOCKING AND CHARGING STATION / ROTATING DOCKING STATION / TABLE BASES
/ HORIZONTAL WALL LAMP BRACKETS / VERTICAL WALL LAMP KIT / VERTICAL SUSPENSION KIT / HORIZONTAL SUSPENSION KIT



Pencil lighting module large white → **LD0802B3**
Pencil lighting module medium white → **LD0801B3**
Pencil lighting module small white → **LD0800B3**
Cansiglio forest
Treviso, Italy



Progetto selezionato dall'Osservatorio Permanente del Design ADI per ADI Design Index 2022.

Project selected by the ADI Permanent Design Observatory for ADI Design Index 2022.

Pencil è un sistema di illuminazione composto da un modulo luminoso a batteria portatile e ricaricabile e dagli accessori dedicati che lo trasformano in lampada da terra, tavolo, parete e a sospensione. Il modulo Pencil può dunque usato nel suo alloggiamento fisso, ma anche rimosso, portato con sé da un ambiente all'altro, e usato autonomamente: continuerà a funzionare a lungo, fino all'esaurimento della carica accumulata (fino a 58 ore). La sorgente a LED produce una luce intensa e ben direzionata, che grazie alla dimmerazione a 4 step e alla funzione di selezione della temperatura di colore consente di calibrare con precisione l'illuminazione di spazi pubblici e privati, anche outdoor.

Pencil is a lighting system consisting of a rechargeable battery-powered cordless light module, and the dedicated accessories that transform it into a wall, pendant, and floor/table lamp. The module can therefore be used in its fixed housing, but also removed and carried from one place to another, and used independently: it will continue to function for a long time, until the accumulated charge power runs out (up to 58 h). The LED source produces a bright, well-directed light, which - thanks to the 4-step dimming and the color temperature selection functions - provides the most appropriate illumination for public and private spaces, also outdoors.

Pencil lighting module medium
corten → **LD0801R3**
Glamping Canonici, Venice



Pencil

Modulo luce Lighting module



Video Pencil



Pencil è un modulo luminoso a batteria, portatile e ricaricabile, disponibile in tre misure. All'estremità del modulo è presente un controllo "touch", che permette l'accensione, la regolazione dell'intensità luminosa (dimmerazione a 4 step) e la selezione della temperatura di colore della luce tra 2700K, 3150K e 4000K. Grazie a un alto indice di protezione, il modulo luminoso è utilizzabile anche all'esterno; resiste inoltre alla nebbia salina (1500 h). Possiede un sistema di controllo elettronico che monitora l'autonomia residua e garantisce un flusso luminoso costante fino all'esaurimento della batteria, permettendo di ottimizzare le ricariche ed effettuarle sempre in maniera corretta. Il modulo Pencil può essere ricaricato in due modi: direttamente tramite caricabatterie (pag. 182); o a contatto sulla base di stazionamento, la quale può essere utilizzata anche solo come alloggio del modulo, per un utilizzo come lampada da terra o da tavolo (pag. 184). Caricabatterie non incluso.

Pencil is a battery-operated portable and rechargeable lighting module, available in three sizes. A "touch" control on one end allows switching on/off, dimming (4-step: 100%, 60%, 30%, 6%) and selecting the color temperature of the light (2700K, 3150K or 4000K). It is suitable for both indoor and outdoor use and salt spray resistant (1500 h). An electronic control system monitors the remaining autonomy and ensures a constant luminous flux until the battery runs out. Recharging is therefore optimized and always properly done. The lighting module can be recharged in two ways: either with the battery charger (pg. 182) or in the docking station, connected to a battery charger (pg. 184). The battery charger is not included.

Pencil lighting module medium white
+ vertical suspension kit
→ LD0801B3 + LD0811B3

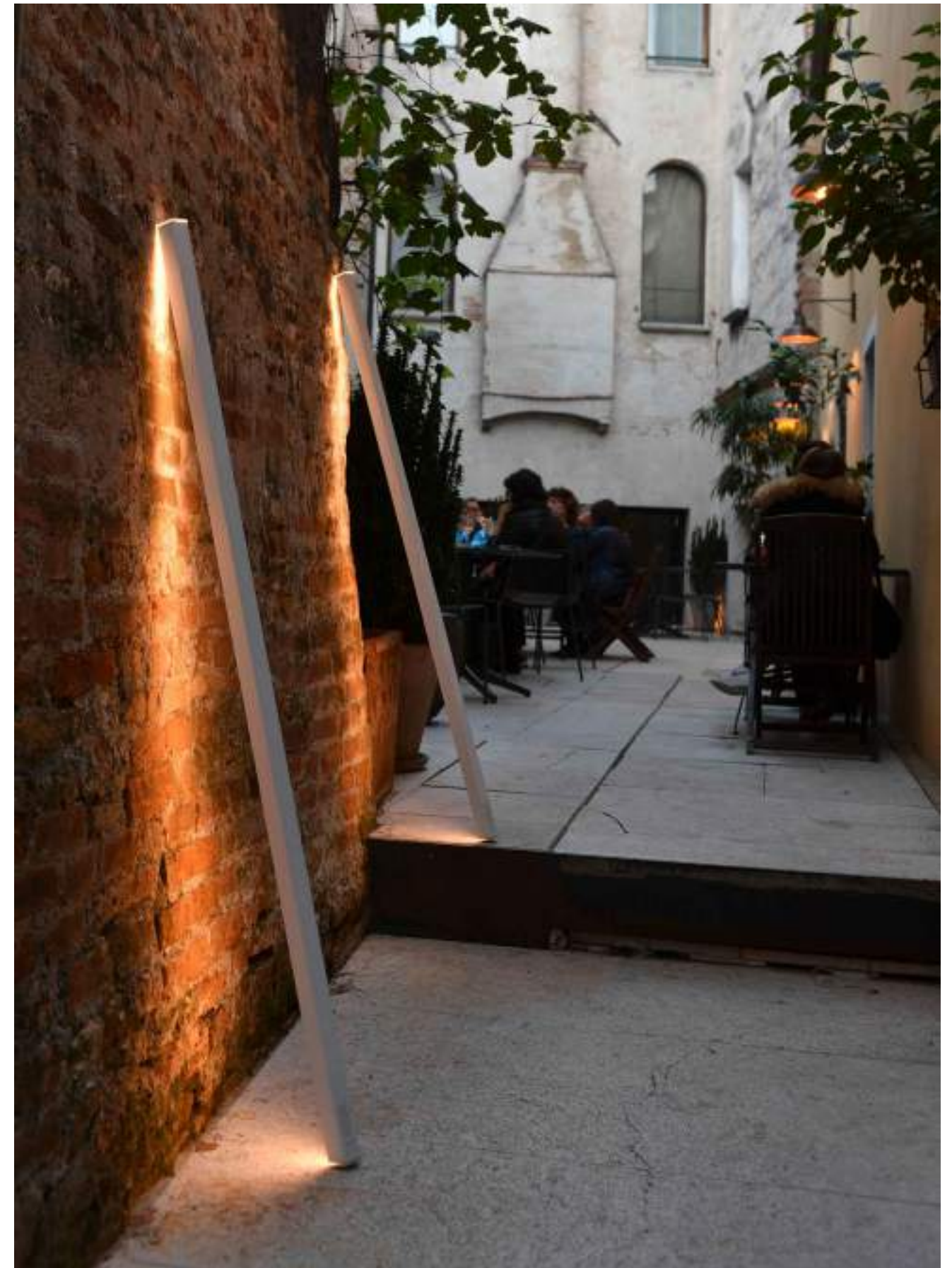

Dati tecnici

Technical data

LED TOUCH DIMMER | 2700-3150-4000K | CRI>90 | 6W | 580-650-680lm | **IP65** | 19 Vdc max 2,5 A

LED TOUCH DIMMER | 2700-3150-4000K | CRI>90 | 12W | 1160-1300-1360lm | **IP65** | 19 Vdc max 2,5 A

LED TOUCH DIMMER | 2700-3150-4000K | CRI>90 | 18W | 1740-1950-2040lm | **IP65** | 19 Vdc max 2,5 A

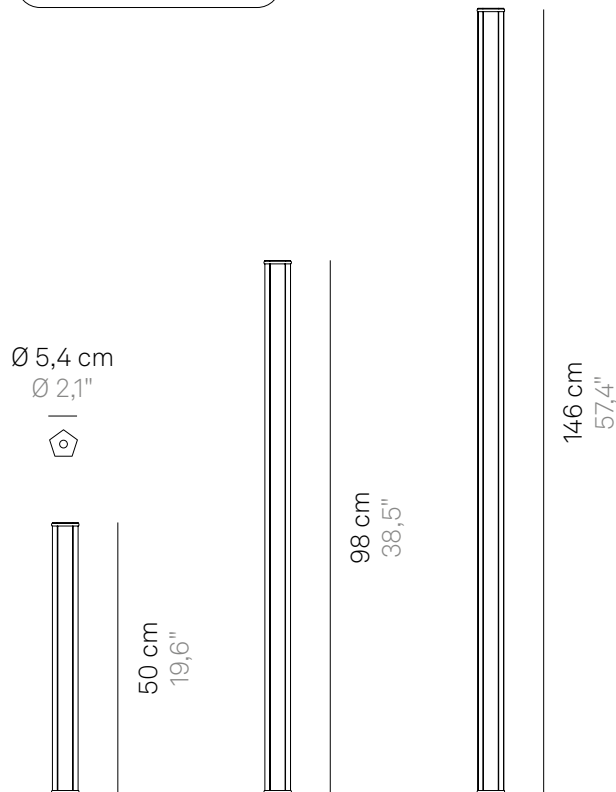

Pacchi batterie al litio ricaricabili e sostituibili
Rechargeable and replaceable lithium battery packs

Durata 8 - 58 h, in base alla regolazione del flusso luminoso

Battery lasts 8 - 58 h, depending on the luminous flux setting.

Ricarica con connettore 3.5/1.3, oppure a contatto (quando usato su base ricarica)

Rechargeable with a 3.5/1.3 connector, or by contact (when used with the charging base)

Tempi di ricarica a 3,16A: 6/9/12 h (rispettivamente per misura piccola/media/grande)

Recharging times at 3.16A: 6/9/12 h (for small/medium/ large size respectively)

Corpo in estrusione d'alluminio verniciato
Painted extruded aluminum fixture

Diffusore in policarbonato opale satinato
Satin opal polycarbonate diffuser

Adatta all'uso esterno (lampada IP65) e interno (lampada su base di ricarica IP20) → legenda pag. 208

Suitable for outdoor (lamp IP65) and indoor use (lamp on charging base IP20) → legend pg. 208

Resistenza agli urti (IK07) e alla nebbia salina (1500h)
Impact resistance (IK07) and salt spray resistance (1500h)

Avvertenze

Remarks

Con gli accessori dedicati, il modulo luminoso Pencil può diventare lampada da terra, tavolo, parete e a sospensione.

Thanks to its dedicated accessories, the lighting module can become a floor, table, wall and pendant lamp.

Componente non incluso

Component not included

Caricabatterie 19Vdc max 2,5A → pag. 182
Charger 19Vdc max 2,5A → pg. 182

* Componente necessario, da acquistare separatamente

* Necessary accessory, yet it must be purchased separately

Finiture

Finishes



Bianco
/ White
RAL 9003

Corten

Grigio scuro
/ Dark grey
RAL 7012

Small

LD0800B3

LD0800R3

LD0800G3

Medium

LD0801B3

LD0801R3

LD0801G3

Large

LD0802B3

LD0802R3

LD0802G3

Completa la tua lampada

Complete your lamp

Caricabatterie → pg. 182
Battery charger → pg. 182

 Supporti parete orizzontale → pg. 190
Horizontal wall lamp brackets → pg. 190

 Base di stazionamento e ricarica → pg. 184
Docking and charging station → pg. 184

 Supporto parete verticale → pg. 192
Vertical wall lamp kit → pg. 192

 Base di stazionamento rotante → pg. 186
Rotating docking station → pg. 186

 Supporto sospensione verticale → pg. 194
Vertical suspension kit → pg. 194

 Supporti tavolo → pg. 188
Table bases → pg. 188

 Supporti sospensione orizzontale → pg. 196
Horizontal suspension kit → pg. 196

Pencil

Caricabatterie Battery charger



LD0800CS

Dati tecnici

Technical data

47,5W • 100-240V • 50-60Hz
19Vdc max 2,5A

CE IP20

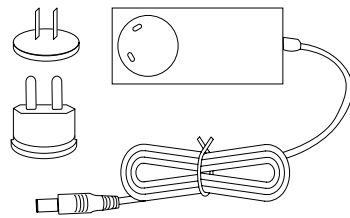

Il caricabatterie permette di ricaricare Pencil in due modi: collegando il cavo (fig. 1) direttamente al modulo luminoso; oppure collegando il cavo alla base di stazionamento e ricarica in cui il modulo viene posizionato (fig. 2). È un componente necessario, da acquistare separatamente: la lunga durata della batteria di Pencil consente infatti di utilizzare un solo caricabatterie per caricare più moduli. Ha una forma compatta, un cavo con attacco 3,5/1,3 e una spina intercambiabile per EU/USA in dotazione; funziona a 100-240V.

The battery charger allows the recharging of Pencil in two ways: either by connecting cable directly to the lighting module (fig. 1); or by connecting the cable to the docking station where the module is placed (fig. 2). It is a necessary accessory, yet it must be purchased separately: the long-lasting battery of Pencil enables to use just one battery charger to charge multiple lighting modules. It has a compact design, a cable with 3.5/1.3 connection and an interchangeable plug suitable for EU / USA standards; dual voltage 100-240V.



Pencil

Base di stazionamento e ricarica*

Docking and charging station*

* Solo se connesso al caricatore

* Only if connected with the charger



Dati tecnici

Technical data

19Vdc max 3,16A

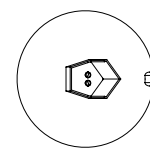
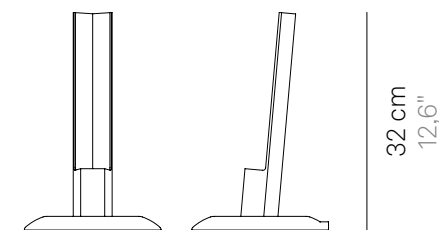

Ø 20 cm
Ø 7,8"

Finiture

Finishes



LD0810B3

Bianco
/ White
RAL 9003



LD0810R3

Corten



LD0810G3

Grigio scuro
/ Dark grey
RAL 7012

Corpo in alluminio verniciato
Painted aluminum fixture

Componente non incluso
Component not included

Caricabatterie → pag. 182
Charger → pg. 182

Accessorio con doppia funzione: è principalmente una base di stazionamento, che trasforma Pencil (pag. 178) in lampada da terra o da tavolo; collegato al caricabatterie, diventa una base di ricarica a contatto per il modulo luminoso. Il modulo luminoso può essere usato nel suo alloggiamento fisso, ma anche rimosso e portato con sé da un ambiente all'altro.

A dual-function accessory: it is mainly used as a docking station, turning the lighting module Pencil (pg. 178) into a floor or table lamp. Connected to the battery charger, it becomes a contact charging base for the lighting module. The lighting module can be used in its fixed housing, or detached and carried from one place to another.

Pencil lighting module large white
+ docking station white
→ **LD0802B3 + LD0810B3**
Osteria Stasera Corder - Treviso, Italy
Photo phEsci Francesco Esci



Pencil

Base di stazionamento rotante*

Rotating docking station*

* Non assolve la funzione di ricarica

* Not a charging station



Dati tecnici

Technical data

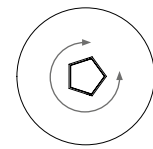
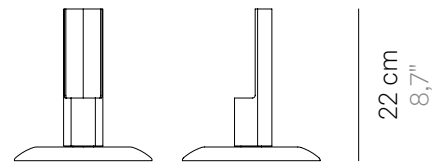

Ø 20 cm
Ø 7,8"

Finiture

Finishes



LD0816B3
Bianco
/ White
RAL 9003



LD0816R3
Corten



LD0816G3
Grigio scuro
/ Dark grey
RAL 7012

Corpo in alluminio verniciato
Painted aluminum fixture

Base di stazionamento che trasforma Pencil (pag. 178) in lampada da terra o da tavolo. Questo accessorio mantiene il modulo luminoso in posizione perpendicolare rispetto al piano di appoggio, e ne permette la rotazione a 360° sull'asse longitudinale, in entrambi i sensi. Il modulo luminoso può essere usato nel suo alloggiamento fisso, ma anche rimosso e portato con sé da un ambiente all'altro. Questa base di stazionamento non assolve la funzione di ricarica.

A docking station that turns Pencil (pg. 178) into a floor lamp or table lamp. This accessory keeps the lighting module in a perpendicular position in relation to the supporting surface, thereby allowing it to rotate 360° on the longitudinal axis, in both directions. The lighting module can be used in its fixed housing or detached and carried from one place to another. This docking station does not charge the lamp.



Pencil

Supporti tavolo Table bases



Dati tecnici Technical data

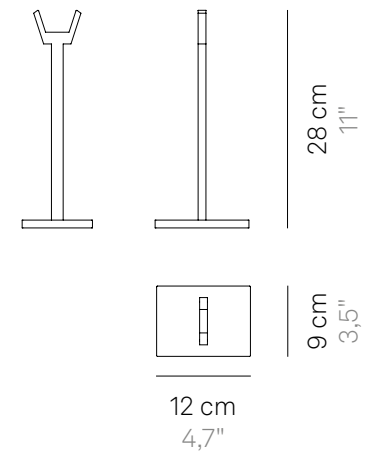

Finiture Finishes



LD081400
Trasparente / Transparent

Supporti in PMMA trasparente
Transparent PMMA structure

Elementi che trasformano Pencil (pag. 178) in una lampada da tavolo. Il modulo luminoso può essere usato nel suo supporto, ma anche rimosso e portato con sé da un ambiente all'altro.

Elements that turn Pencil (pg. 178) into a table lamp.
The lighting module can be used in its fixed housing or detached and carried from one place to another.



Pencil lighting module small white
+ table bases
→ LD0800B3 + LD081400

Pencil

Supporti parete orizzontale Horizontal wall lamp brackets



Dati tecnici Technical data

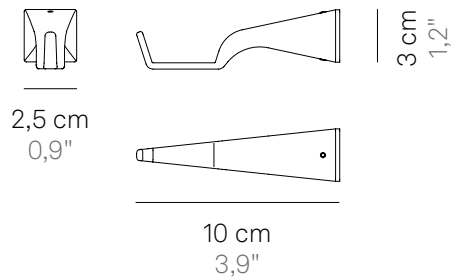

Finiture Finishes



LD0813B3
Bianco
/ White
RAL 9003

LD0813R3
Corten

LD0813G3
Grigio scuro
/ Dark grey
RAL 7012

Supporti in pressofusione d'alluminio verniciato
Painted die-cast aluminum elements



Pencil lighting module small white
+ horizontal wall lamp brackets white
→ **LD0800B3 + LD0813B3**

Supporti che trasformano Pencil (pag. 178) in una lampada da parete orizzontale. Il modulo luminoso può essere usato nel suo supporto fisso, ma anche rimosso e portato con sé da un ambiente all'altro.

Brackets that turn Pencil (pg. 178) into a horizontal wall lamp. The lighting module can be used in its fixed housing or detached and carried from one place to another.

Pencil

Supporto parete verticale Vertical wall lamp kit



Dati tecnici Technical data

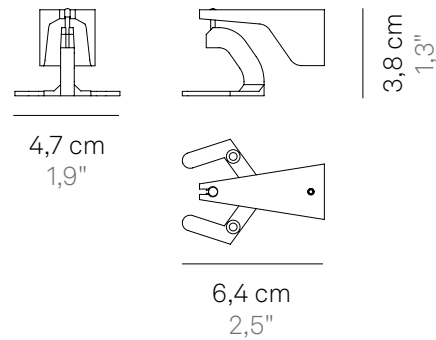

Finiture Finishes



LD0815B3
Bianco
/ White
RAL 9003



LD0815R3
Corten



LD0815G3
Grigio scuro
/ Dark grey
RAL 7012

Supporto in pressofusione d'alluminio
verniciato con particolari cromati
Painted die-cast aluminum element with
chromed details

Elemento che trasforma Pencil (pag. 178) in una lampada da parete verticale, che ruota sul proprio asse longitudinale a 360°, in entrambi i sensi. Il modulo luminoso può essere usato nel suo supporto fisso, ma anche rimosso e portato con sé da un ambiente all'altro.

Element that turns Pencil (p. 178) into a vertical wall lamp, rotating on its longitudinal axis by 360°, in both directions. The lighting module can be used in its fixed housing or detached and carried from one place to another.



Pencil lighting module medium white
+ vertical wall lamp kit white
→ **LD0801B3** + **LD0815B3**

Pencil

Supporto sospensione verticale

Vertical suspension kit



Dati tecnici

Technical data

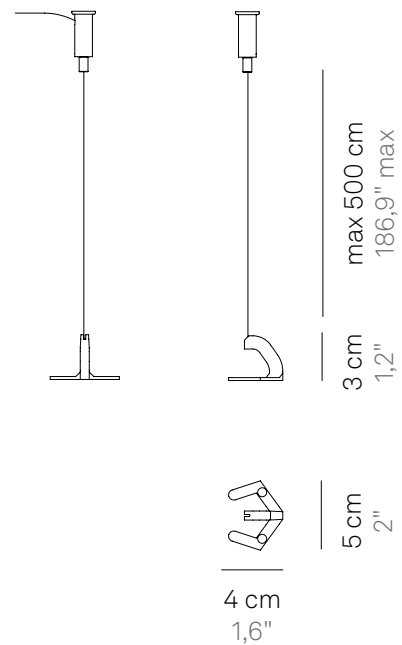

Finiture

Finishes



LD0811B3
Bianco
/ White
RAL 9003



LD0811R3
Corten



LD0811G3
Grigio scuro
/ Dark grey
RAL 7012

Supporto in pressofusione d'alluminio verniciato con particolari cromati
Painted die-cast aluminum element with chromed details

Componenti inclusi

Components included

Cavo in acciaio e staffe
Steel cable and brackets

Elemento che trasforma Pencil (pag. 178) in una lampada a sospensione verticale. Il modulo luminoso può essere usato nel suo supporto fisso, ma anche rimosso e portato con sé da un ambiente all'altro.

Element that turns Pencil (pg. 178) into a vertical suspension lamp. The lighting module can be used in its fixed housing, or detached and carried from one place to another.



Pencil lighting module small dark grey
+ vertical suspension kit dark grey
→ **LD0800G3 + LD0811G3**

Pencil

Supporti sospensione orizzontale

Horizontal suspension kit



Dati tecnici Technical data

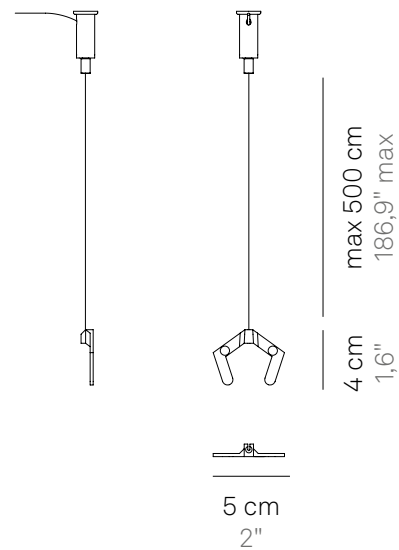

Finiture Finishes



LD0812B3
Bianco
/ White
RAL 9003

LD0812R3
Corten

LD0812G3
Grigio scuro
/ Dark grey
RAL 7012

Supporto in pressofusione d'alluminio
verniciato con particolari cromati
Painted die-cast aluminum element with
chromed details

Componenti inclusi
Components included

Cavo in acciaio e staffe
Steel cable and brackets

Elementi che trasformano Pencil (pag. 178) in una lampada a sospensione orizzontale a luce diretta. Il modulo luminoso può essere usato nel suo supporto fisso, ma anche rimosso e portato con sé da un ambiente all'altro.

Elements that turn Pencil (pg. 178) into a horizontal suspension lamp. The lighting module can be used in its fixed housing or detached and carried from one place to another.



Pencil lighting module medium dark grey
+ horizontal suspension kit dark grey →
LD0801BG + LD0812G3

Accessori

Accessories



LD0350RB
Base di ricarica a contatto
Contact charging base
(Poldina, Poldina mini)



LD0490RB
Base di ricarica a contatto
Contact charging base
(Poldina micro)



LD0395RB
Base di ricarica a contatto
Contact charging base
(Poldina L desk)

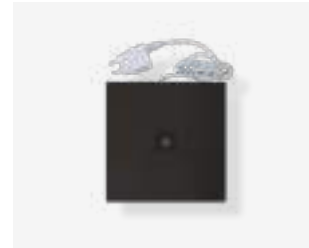

LD0390RB
Base di ricarica a contatto
Contact charging base
(Poldina L)



LD0800CS
Caricabatterie con connettore
3.5/1.3 (pag. 182)
(Pencil modulo luce,
Pencil base ricarica)
Charger with a 3.5/1.3
connector (page 182)
(Pencil lighting module,
Pencil charging base)
48W
INPUT: AC 100-240V | 50-60Hz
OUTPUT: 19Vdc - max 2,5 A



LD0490UA
Caricabatterie con entrata USB-a
USB-a port power charger
(Poldina micro, Swap mini,
Push-up)
INPUT: AC 100-240V | 50-60Hz
OUTPUT: 5Vdc - max 1 A



LD0300UC
Caricabatterie con doppia entrata
USB-a e spina intercambiabile
(EU/USA/UK)
Dual USB-a port power charger
and an interchangeable plug
suitable for EU/USA/UK
(Sister Light)
INPUT: AC 100-240V | 50-60Hz
OUTPUT: 5Vdc - max 2,1 A



CBL04200010000000
Cavo di ricarica con entrata USB-c
Charging cable with USB-c input
(Sister Light)



LD0360RB
Base di ricarica a contatto
Contact charging base
(Poldina XXL)



LD0850RB
Base di ricarica a contatto
Contact charging base
(Olivia, Olivia mini)



LD0870RB
Base di ricarica a contatto
Contact charging base
(Ofelia)



LD0688RB
Base di ricarica a contatto
(Poldina picchetto, Poldina
sospensione, Poldina parete)
Contact charging base
(Poldina lamp with peg,
Poldina suspension lamp,
Poldina wall lamp)
INPUT: AC 100-240V | 50-60Hz
OUTPUT: 5Vdc max 1A



LD0340RA
Caricatore multiplo 8 prese USB-a
8 x USB-a ports multi charger
40W
INPUT: AC 100-240V | 50-60Hz
OUTPUT: 5Vdc - max 8A (8 pcs.)



LD0350RP
Base di ricarica a contatto
multipla 6 posti
Multi-contact charging base
6 slots
(Poldina, Poldina mini, Poldina
Reverso, Pina, Swap, Swap
mini, Push-up, Home, Dama,
Olimpia)



LD0490RP
Base di ricarica a contatto
multipla 12 posti
Multi-contact charging base
12 slots
(Poldina micro)



LD0870RP
Base di ricarica a contatto
multipla 6 posti
Multi-contact charging base
6 slots
(Olivia, Olivia mini, Ofelia)



Base di ricarica a contatto
Contact charging base
LD0420RB (Poldina Reverso)
LD0650RB (Pina)
LD0610RB (Dama)
LD0900RB (Olimpia)
LD1010RB (Swap)
LD0258RB (Home)



LD1011RB
Base di ricarica a contatto
Contact charging base
(Swap mini)



LD1050RB
Base di ricarica a contatto
Contact charging base
(Push-up)



LD0280UA
Caricabatterie con entrata USB-a e
cavo di ricarica con entrata USB-c
Charger with USB-a input and
charging cable with USB-c input
INPUT: AC 100-240V | 50-60Hz
OUTPUT: 5Vdc - max 1 A



LD0420V1
Contenitore multiuso
Multipurpose container tray
(Poldina Reverso)



LD0300KT
Kit per fissaggio meccanico
al tavolo
Kit for mechanical fixing
to a table
(Sister Light tavolo)



LD0300KN
Kit per fissaggio magnetico
(Sister Light)



LD0300KM
Kit per fissaggio meccanico
(Sister Light)

Base di ricarica a contatto multipla (max 6 posti)

Multi-contact charging base (max 6 slots)

→ Poldina, Poldina mini, Poldina Reverso, Pina, Swap, Swap mini, Push-up, Home, Dama, Olimpia



→ LD0350RP

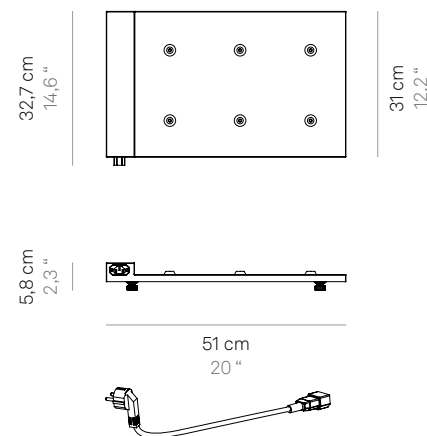

35W
INPUT: AC 100-240V | 50-60Hz
OUTPUT: 5Vdc max 6A

Base di ricarica a contatto multipla (max 6 posti) e modulare: più basi possono essere collegate in sequenza per caricare contemporaneamente più lampade. Particolarmente adatto all'uso professionale. Modular multi-contact (max 6 slots) charging base: they can be connected in sequence to simultaneously charge multiple set of lamps. Particularly suitable for professional use.

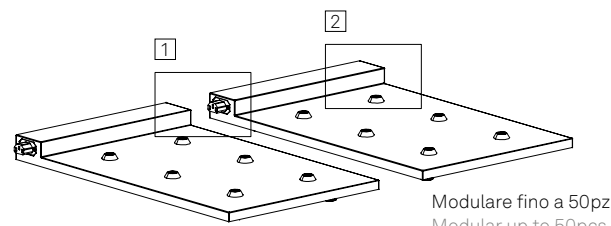
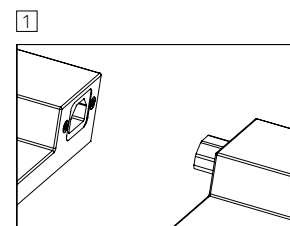

Modulare fino a 50pz
Modular up to 50pcs

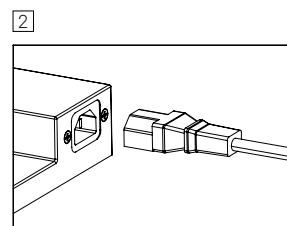
**Base di ricarica a contatto multipla (max 12 posti)**

Multi-contact charging base (max 12 slots)

→ Poldina micro



→ LD0490RP

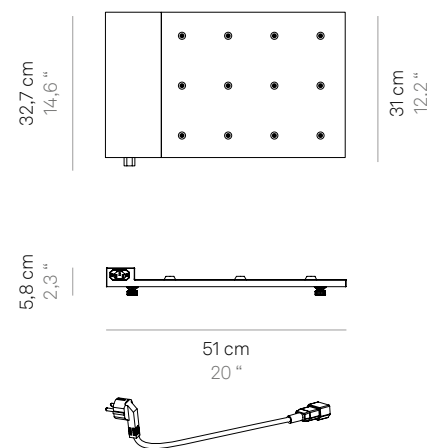

35W
INPUT: AC 100-240V | 50-60Hz
OUTPUT: 5Vdc max 12A

Base di ricarica a contatto multipla (max 12 posti) e modulare: più basi possono essere collegate in sequenza per caricare contemporaneamente più lampade. Particolarmente adatto all'uso professionale. Modular multi-contact (max 12 slots) charging base: they can be connected in sequence to simultaneously charge multiple set of lamps. Particularly suitable for professional use.

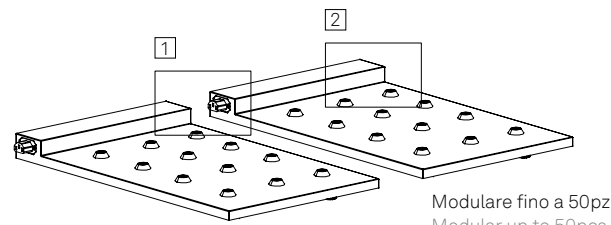
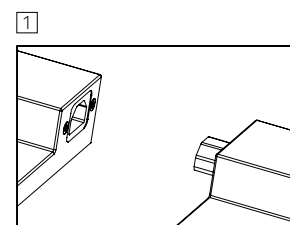

Modulare fino a 50pz
Modular up to 50pcs

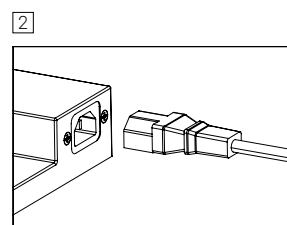
**Base di ricarica a contatto multipla (max 6 posti)**

Multi-contact charging base (max 6 slots)

→ Olivia, Olivia mini, Ofelia



→ LD0870RP

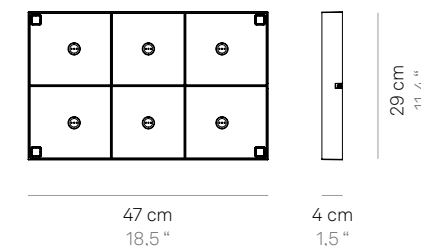

45W
INPUT: AC 100-240V | 50-60Hz
OUTPUT: 9Vdc max 5A

Base di ricarica a contatto multipla (max 6 posti) e modulare: più basi possono essere impilate (fino a max 3 livelli) per caricare contemporaneamente più lampade. Particolarmente adatto all'uso professionale. Modular multi-contact (max 6 slots) charging base: they can be stacked (up to max 3 levels) to simultaneously charge multiple set of lamps. Particularly suitable for professional use.

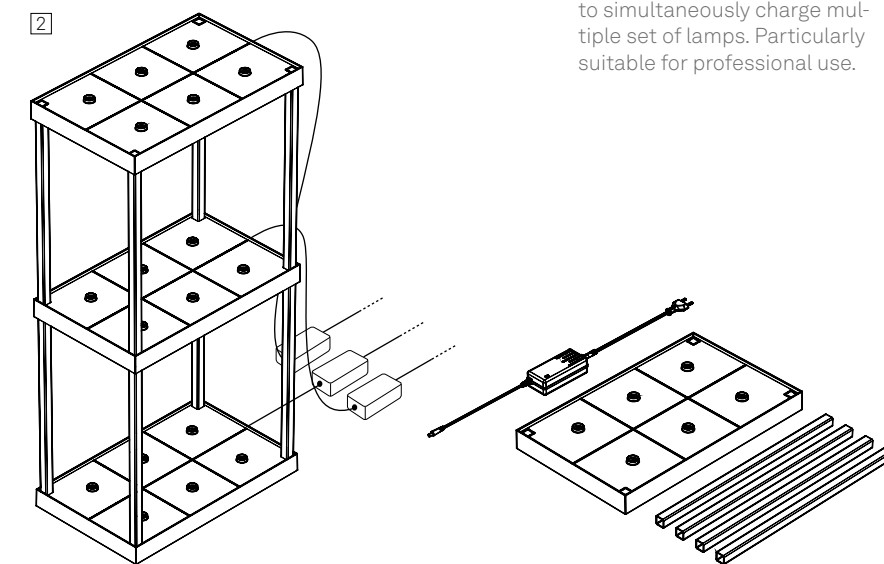
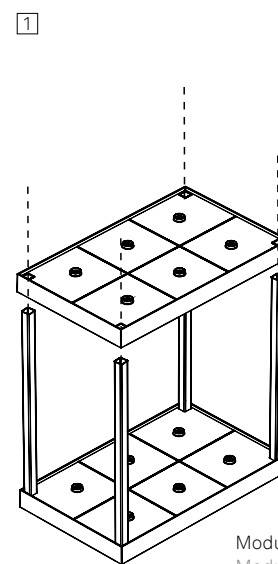

Modulare fino a 3 livelli.
Modular up to 3 levels.

Caricatore multiplo 8 prese USB

8 x USB ports multi charger



→ LD0340RA

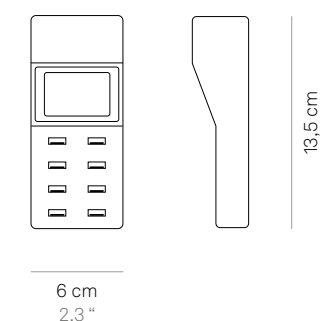

40W
INPUT: AC 100-240V | 50-60Hz
OUTPUT: 5Vdc - max 8A (8 pcs.)

Caricatore multipresa USB (8 x USB-A). Permette la carica di max 8 dispositivi contemporaneamente. Un display mostra graficamente il livello delle batterie in ricarica. Particolarmente adatto all'uso professionale. USB multi-socket charger (8 x USB-A). Can charge of up to 8 devices simultaneously. A graphic display shows the level of the batteries being charged. Particularly suitable for professional use.

Batterie ricaricabili

Rechargeable batteries

Le batterie ricaricabili sono soggette ad usura. La vita delle batterie, il cui standard è di circa 450 ricariche, può essere ridotta da alcuni fattori come: ① la modalità non corretta di ricarica (la lampada va ricaricata quando è scarica: circa il 10% della sua autonomia residua); ② lunghi periodi di stazionamento senza utilizzo; ③ lunghi periodi di stazionamento su base di ricarica in tensione anche se la lampada risulta carica; ④ l'utilizzo di accessori non originali per la ricarica; ⑤ l'esposizione del prodotto a temperature molto alte o molto fredde. Quando le lampade non si ricaricano più o l'autonomia risulta molto ridotta, le batterie devono essere sostituite. I ricambi delle lampade ricaricabili Zafferano sono disponibili a catalogo e identificati con apposito codice. La garanzia sulle batterie è valida solo per difetti di fabbricazione, che si manifestano al primo utilizzo.

All rechargeable batteries are subject to wear when used. The life of batteries, which can generally be recharged 450 times, may be reduced by certain factors: ① incorrect recharging mode (the lamp must be recharged when it is flat: about 10% of its remaining autonomy); ② when left unused for a long time; ③ when left for a long time on a live recharging base even if the lamp is recharged; ④ when non-original accessories are used for recharging; ⑤ when the product is exposed to very high or very low temperatures. When the lamps no longer recharge or their autonomy after recharging is very short, the batteries must be replaced. Spare parts for Zafferano rechargeable lamps can be found in the catalogue and identified by a special code. The warranty for batteries is only valid for manufacturing defects, if occurred at first use.

BAT04701906701900 3,7V | 1x2200mA/H
Pacco batteria sostitutiva singola (necessari 2 pz., per **Pina tavolo, Push-up tavolo, Home tavolo**; necessari 3 pz., per **Poldina L desk tavolo, Poldina L terra-tavolo**)
Single replacement battery pack (x2 pcs., needed for **Pina table lamp, Push-up table lamp, Home table lamp**; x 3 pcs., needed for **Poldina L desk table lamp, Poldina L floor-table lamp**)



BAT04704004001000 3,7V | 1x1900mA/H
Pacco batteria sostitutiva singola (necessario 1 pz., per **Poldina micro tavolo**)
Single replacement battery pack (1 pc., needed for **Poldina micro table lamp**)



BAT04703706701900 3,7V | 2x2200mA/H
Pacco batteria sostitutiva doppia (necessario 1 pz., per **Poldina tavolo, Poldina mini tavolo, Poldina picchetto, Poldina sospensione, Poldina parete, Poldina Reverso tavolo, Olivia, Olivia mini, Ofelia, Dama, Olimpia**; necessari 3 pz., per **Poldina XXL terra-tavolo**)
Double replacement battery pack (1 pc., needed for **Poldina table lamp, Poldina mini table lamp, Poldina lamp with peg, Poldina suspension lamp, Poldina wall lamp, Poldina Reverso table lamp, Olivia, Olivia mini table lamp, Ofelia, Dama, Olimpia**; 3 pcs., needed for **Poldina XXL floor-table lamp**)



BAT04701906701902 3,7V | 1x2600mA/H
Pacco batteria sostitutiva singola (necessari 2 pz., per **Swap tavolo, Swap tavolo mini**)
Single replacement battery pack (2 pcs., needed for **Swap table lamp, Swap mini table lamp**)



BAT04705506701900 3,7V | 7500mA/H
Pacco batteria sostitutiva tripla (necessario 1 pz., per **Sister Light tavolo, Sister Light mini tavolo, Sister Light picchetto, Sister Light parete**)
Triple replacement battery pack (x 1 pc., needed for **Sister Light table lamp, Sister Light mini table lamp, Sister Light lamp with peg, Sister Light wall lamp**)



BAT04702719700300 11,1V | 5000mA/H
Pacco batteria sostitutiva per **modulo Pencil piccolo**
Replacement battery pack for **small Pencil module**



BAT04702739200600 11,1V | 10000mA/H
Pacco batteria sostitutiva per **modulo Pencil medio**
Replacement battery pack for **medium Pencil module**



BAT04702758700900 11,1V | 15000mA/H
Pacco batteria sostitutiva per **modulo Pencil grande**
Replacement battery pack for **large Pencil module**



Video tutorial:
sostituzione batterie
Tutorial video:
battery replacement

Personalizzazione

Customization

Su richiesta, con quantitativi minimi d'ordine, è possibile personalizzare le lampade con un servizio di logatura.

Available on request, with minimum ordering quantities, customised logo pad-printing service.



Punti personalizzabili
Customizable spots

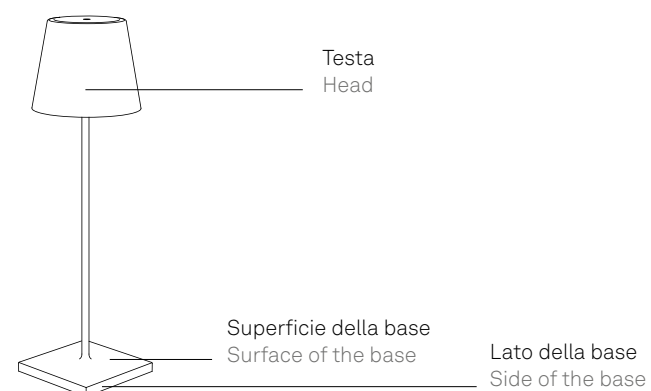

Bauli: logatura sul lato della base
Bauli: customization on the side of the base
(Poldina table lamp pro, LD0340P3)



Barilla: logatura sulla superficie della testa
Barilla: customization on the surface of the head
(Sister Light table lamp pro, LD030003 + LD0300R3)



Bulldog: logatura sulla testa
Bulldog: customization on the head
(Poldina micro table lamp pro, LD0490D3)

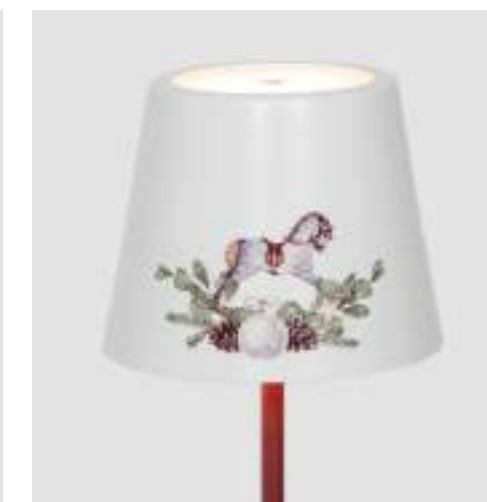

Logatura su cover in metallo, per modelli Poldina
Customization on metallic cover, available for Poldina



Zafferano: logatura sulla superficie della base
Zafferano: customization on the surface of the base
(Poldina table lamp pro, LD0340B3)

Espositore

Display unit

Espositore per lampade portatili Zafferano, realizzato in cartone stampato a colori su tutti i lati. Sul ripiano è possibile esporre una lampada (vincolabile tramite un cavo di sicurezza), la sua base di ricarica e/o i cataloghi della collezione.

La parte inferiore a giorno permette di alloggiare fino a 28* scatole di lampade portatili. Il basamento dell'espositore, realizzato in legno, è dotato di quattro ruote piroettanti (di cui le due posteriori con freno), che rendono agile lo spostamento e sicuro lo stazionamento dell'espositore.

* Quantità riferita ai modelli da tavolo
Poldina, Olivia, Ofelia, Pina

Display unit for Zafferano cordless lamps, made of solid cardboard printed in color on all sides. On the shelf, it is possible to display a lamp (which can be secured with a safety cable), its charging base and / or the catalogs of the collection. The open lower part accommodates up to 28* boxes of portable lamps. The display unit base, made of wood, is equipped with four swiveling wheels (two rear ones with brakes), for easy moving and secure parking.

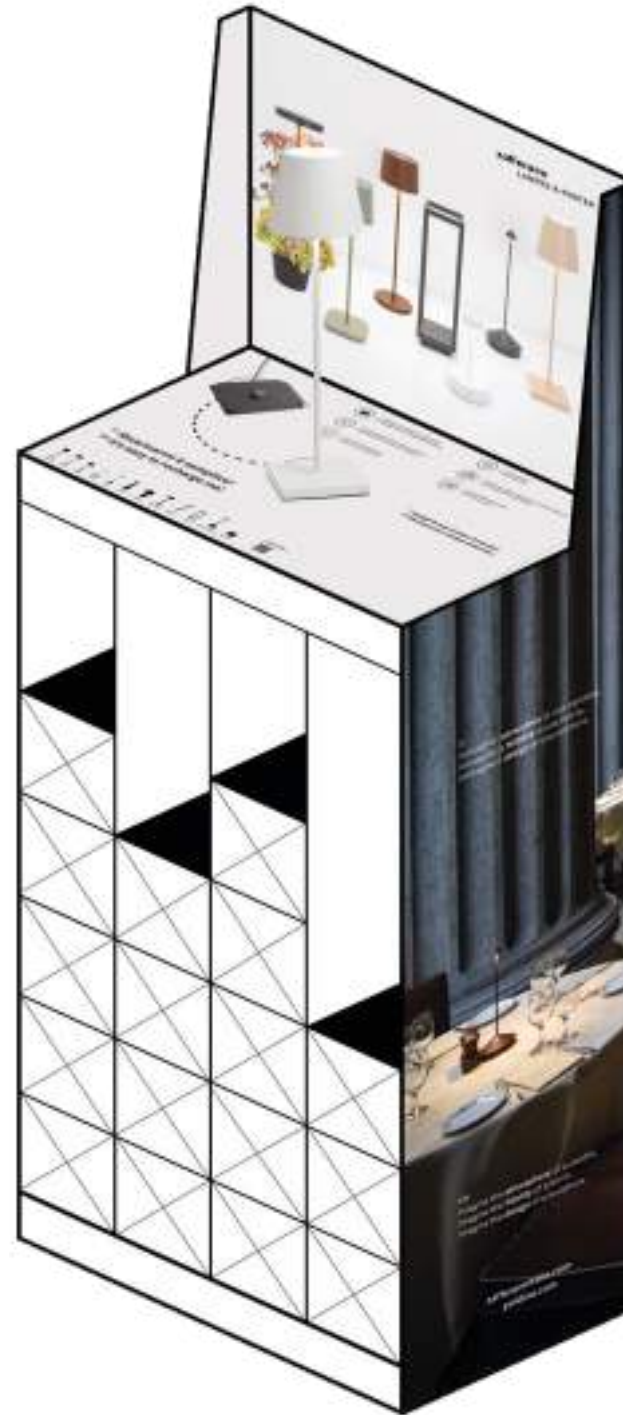

* This quantity refers to table lamps
Poldina, Olivia, Ofelia, Pina



Indice per codice

Code index

LD0258B3 LD0258R3 LD0258N3	pg.139	LD0360B3 LD0360R3 LD0360N3	pg.41	LD0800B3 LD0800R3 LD0800G3 LD0801B3 LD0801R3 LD0801G3 LD0802B3 LD0802R3 LD0802G3	pg.181	LD1650B3 LD1650R3 LD1650N3 LD1650D3 LD1650S3 LD1650BFO LD1650BFA LD1650RFR	pg.97
LD0300O3 LD0300A3 LD0300R3 LD0300V3 LD0300B3	pg.161	LD0390B3 LD0390R3 LD0390N3	pg.37	LD0395B3 LD0395R3 LD0395N3	pg.33	LD1870B3 LD1870R3 LD1870N3 LD1870S3 LD1870G3	pg.77
LD0302R3 LD0302V3	pg.169	LD0420B3 LD0420R3 LD0420N3 LD0420S3 LD0420G3	pg.69	LD0850B3 LD0850R3 LD0850N3 LD0850BFO LD0850BFA LD0850RFR	pg.85		
LD0306O3 LD0306R3 LD0306V3	pg.165	LD0490B3 LD0490R3 LD0490N3 LD0490D3 LD0490S3 LD0490G3 LD0490P3 LD0490F3 LD0490K3 LD0490L3 LD0490V3 LD0490Z3 LD0490O3 LD0490C3	pg.28	LD0860B3 LD0860R3 LD0860N3 LD0860K3 LD0860L3 LD0860V3 LD0860Z3	pg.89		
LD0308R3 LD0308V3	pg.173	LD0900B3 LD0900N3 LD0900O3 LD0900C3 LD0900E3		LD1010B3 LD1010R3 LD1010N3	pg.153		
LD0320B3 LD0320R3 LD0320N3 LD0320S3 LD0320BFO LD0320BFA LD0320RFR LD0320O3 LD0320C3	pg.22	LD0610B3 LD0610N3	pg.147	LD1011B3 LD1011R3 LD1011N3 LD1011O3 LD1011C3 LD1011K3 LD1011L3 LD1011V3 LD1011Z3	pg.113		
LD0340B3 LD0340R3 LD0340N3 LD0340S3 LD0340G3 LD0340A3 LD0340P3 LD0340F3 LD0340X3 LD0340M3 LD0340O3 LD0340C3 LD0340BFO LD0340BFA LD0340RFR	pg.14	LD0682B3 LD0682R3 LD0682N3	pg.45	LD0686B3 LD0686R3 LD0686N3	pg.49		
LD0340FP1 LD0340BP2 LD0340BP3 LD0340BP4 LD0340RP5	pg.19	LD0688B3 LD0688R3 LD0688N3 LD0689B3 LD0689N3 LD0689R3	pg.53	LD1050B3 LD1050R3 LD1050N3 LD1050S3	pg.133		

<p>CE</p> <p>CE Dichiara che il prodotto soddisfa gli standard dell'UE per la salute, la sicurezza e la protezione ambientale. Declares that the product meets EU standards for health, safety, and environmental protection.</p>	<p></p> <p>CLASS II Apparecchio dotato di doppio isolamento e/o isolamento rinforzato in ogni parte e senza dispositivo di messa a terra. Light fitting equipped with double isolation and/or isolation reinforced in every part and without earthing device.</p>	<p></p> <p>CLASS III Apparecchio basato su un'alimentazione a bassissima tensione di sicurezza, in cui non si producono tensioni superiori alla stessa. Light fitting based on a very low safety voltage power supply, in which no tensions higher than the same are produced.</p>	<p>IP</p> <p>IP PROTECTION DEGREE IP20: apparecchio protetto dalla penetrazione di corpi solidi di dimensioni maggiori a 12mm e non protetto dai liquidi. IP54: apparecchio protetto da polveri e da spruzzi d'acqua. IP65: apparecchio fortemente protetto da polveri e da getti d'acqua. IP20: protected from the penetration of solid objects greater than 12 mm and non protected from liquids. IP54: protected from dust and splashing water. IP65: highly protected from dust and water jets.</p>
<p></p> <p>DIMMABLE Indica che è possibile regolare l'intensità luminosa della lampada. Indicates that the light intensity of the lamp can be adjusted.</p>			

Headquarters
Zafferano SRL
Viale dell'industria 26
31055 Quinto di Treviso (TV), Italy
T +39 0422 470507
F +39 0422 470400
vendite@zafferanoitalia.com

Subsidiary
Zafferano America LLC
301 Penhorn Avenue
Suite 5,
Secaucus, NJ 07094
T +1 888 744 5277
info@zafferanoamerica.com

Showrooms
Zafferano Store Milano
Via Fatebenefratelli, 23
Milan (Italy)
Zafferano Store Treviso
Viale dell'Industria, 26
Quinto di Treviso (Italy)

Art Direction, Graphic Design
Zafferano Design

Photography
Claudio Mainardi
Alberto Sinigaglia
Quasar

Poems
Federico de Majo

©2023 Peanuts Worldwide LLC
www.peanuts.com

October 2023

Acknowledgements
Porto Caleri, Rovigo
Caglieron Caves, Treviso
Storga river springs, Treviso
Morgano countryside, Treviso
Piave riverbed, Treviso
Brent de l'Art, Belluno
Rosolina pine forest, Rovigo
Cansiglio forest, Treviso
Euganean hills, Padua
(Italy)

Lago Design, Villa del Conte
Padua, Italy

L'azienda si riserva di apportare modifiche e/o migliorie di carattere tecnico ed estetico ai propri modelli e prodotti in qualsiasi momento e senza preavviso.
The company reserves the right to make modifications and improvements of a technical or aesthetic nature to the products at any time without notice.

Il prodotto è protetto da garanzia, a norma di legge.
The product is covered by a warranty, according to the law.

© Copyright Zafferano SRL

CATLAP23-10

zafferanoitalia.com
zafferanolampesaporter.com
zafferanoamerica.com
poldina.com

zafferano
LAMPES-À-PORTER